









 **psi**

max. 7.25  145  72.5  14.5

 **bar**

max. 0,5  10  5  1

 **°F**

max. 158°   140°

 **°C**

max. 70°   60°

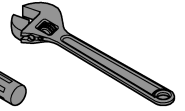
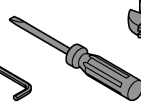
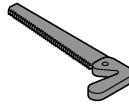
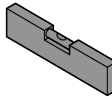
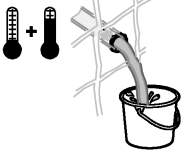

1

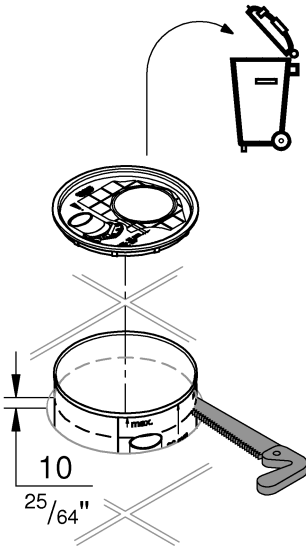

2

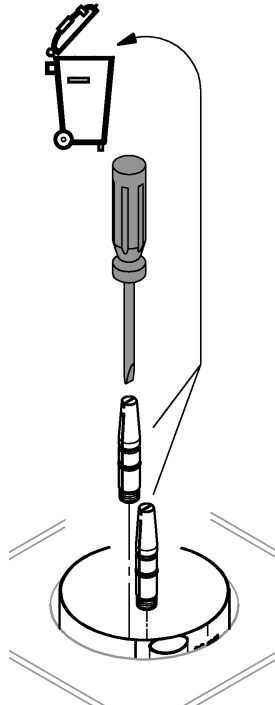

3

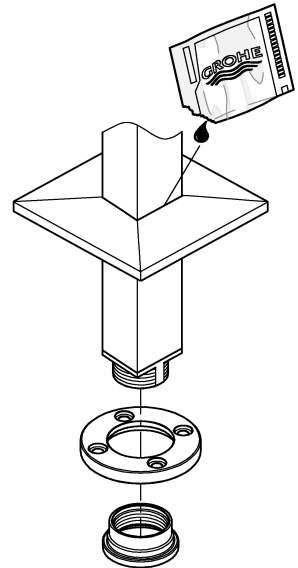



4

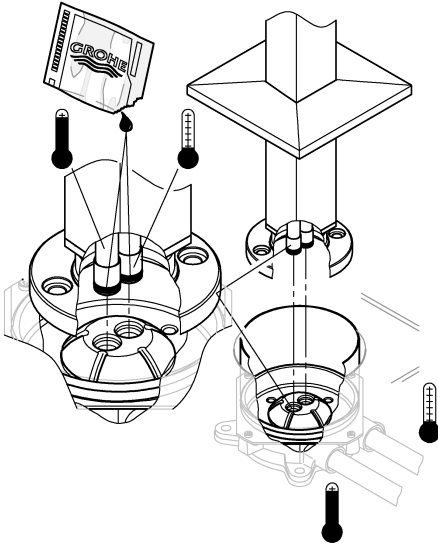

5

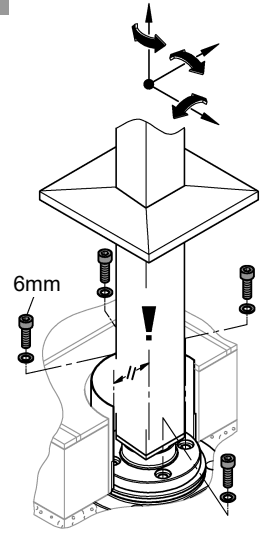

6

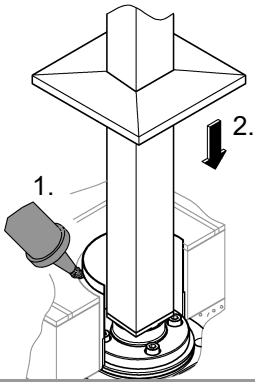

7

