

18 394
18 729

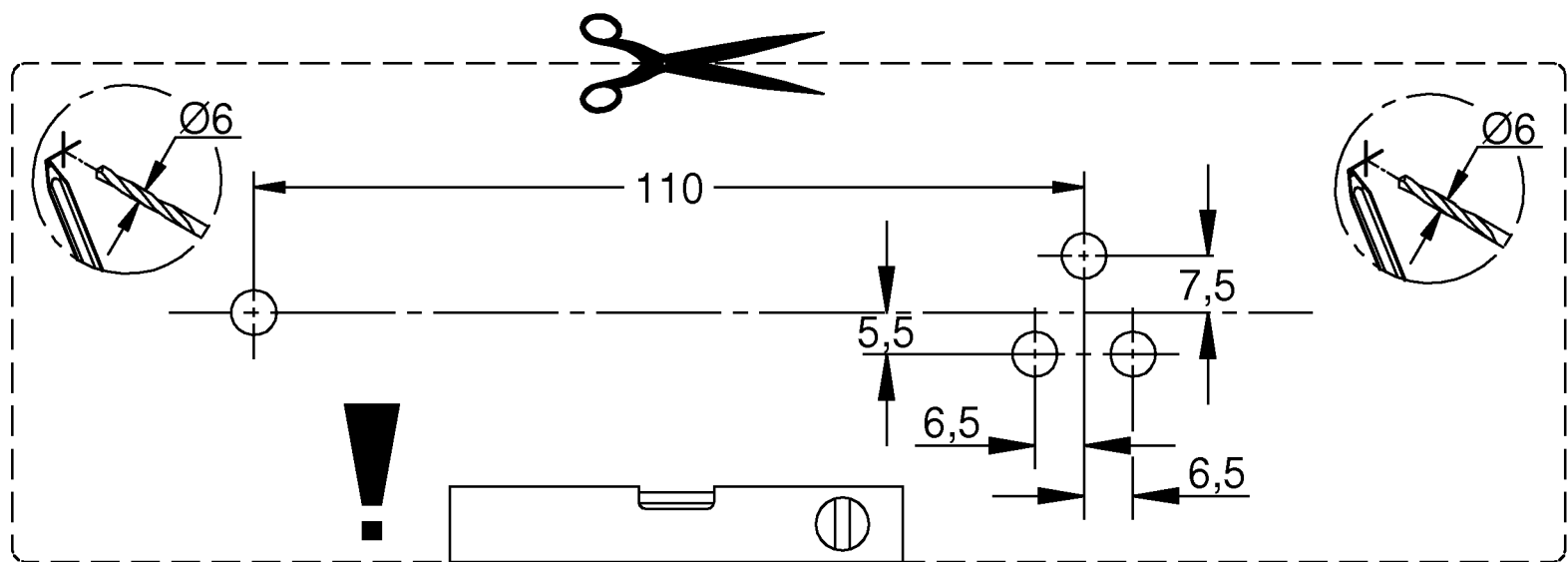

1.

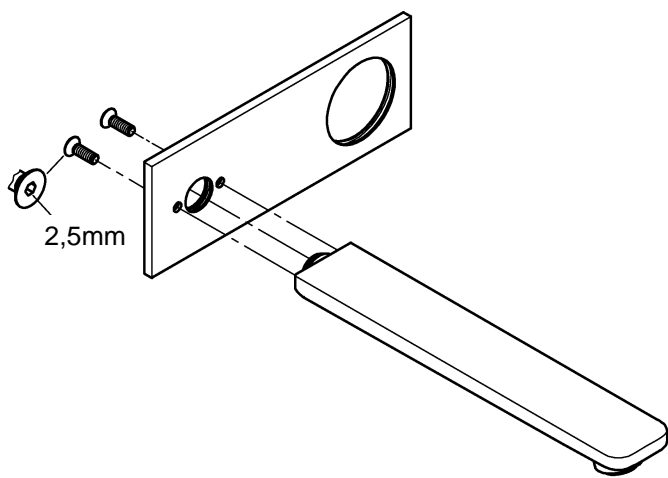

2.

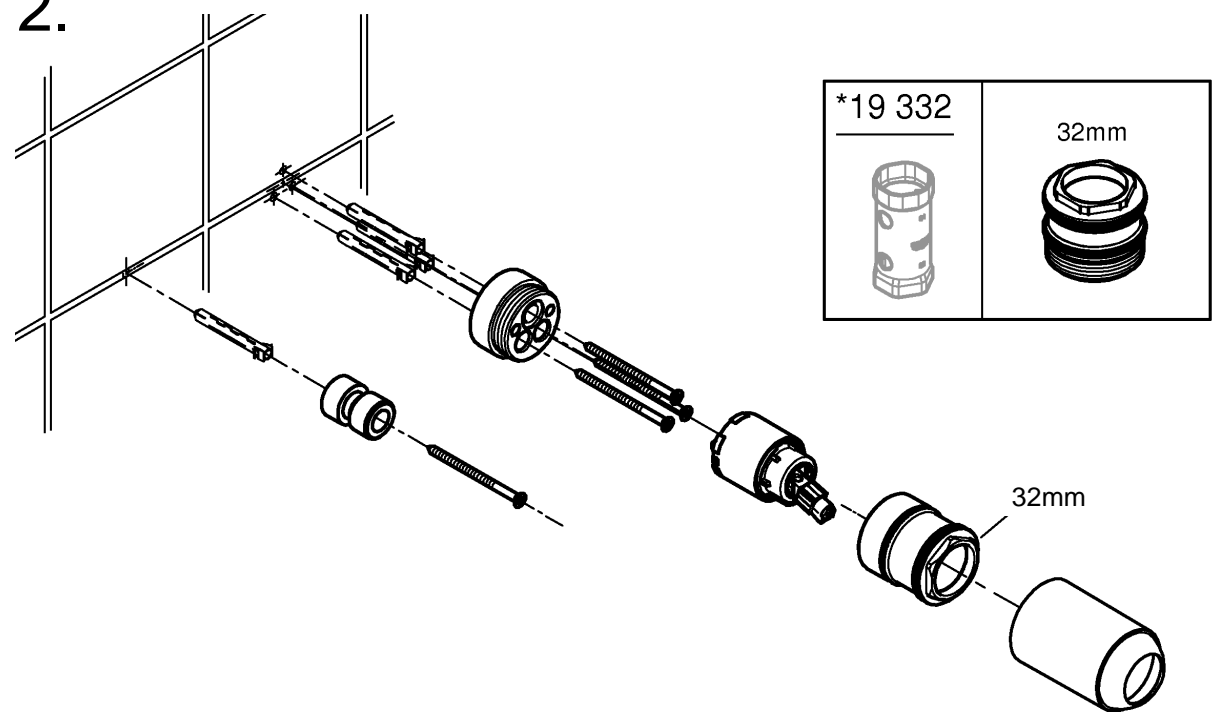

3.

