

28 549

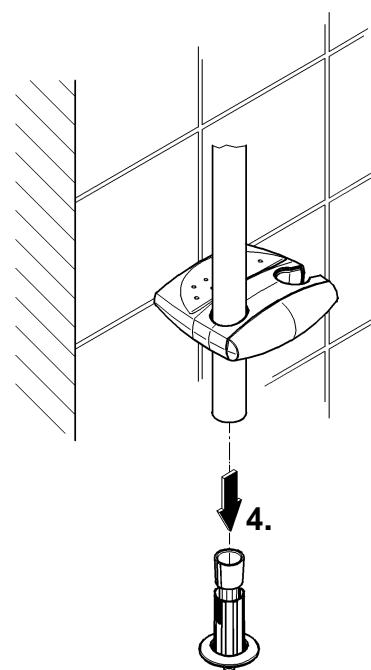

28 566

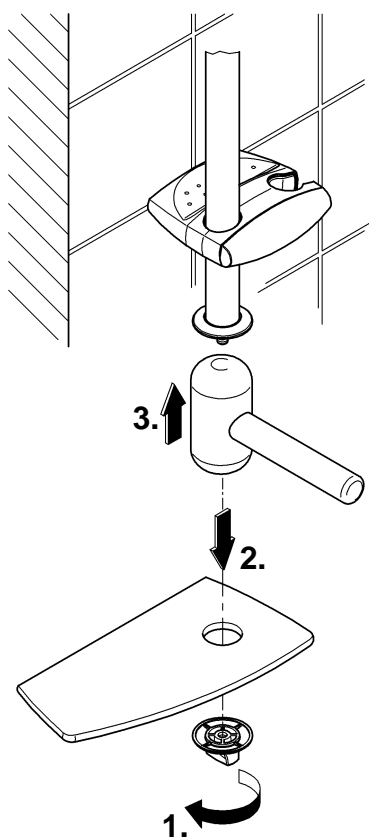
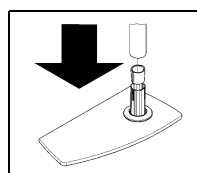
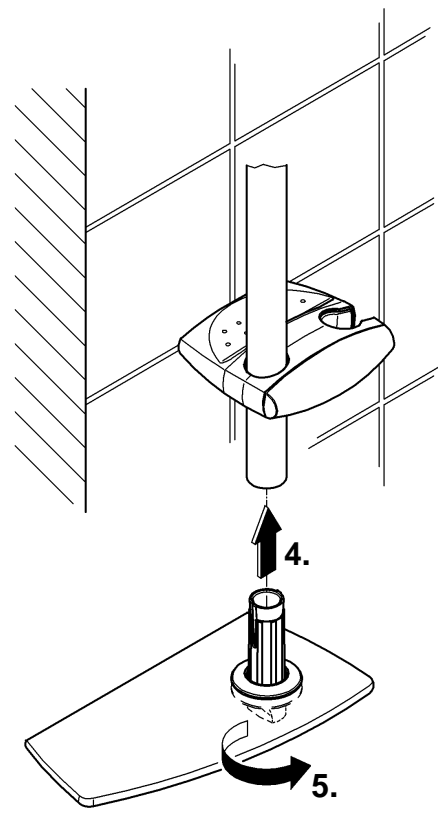
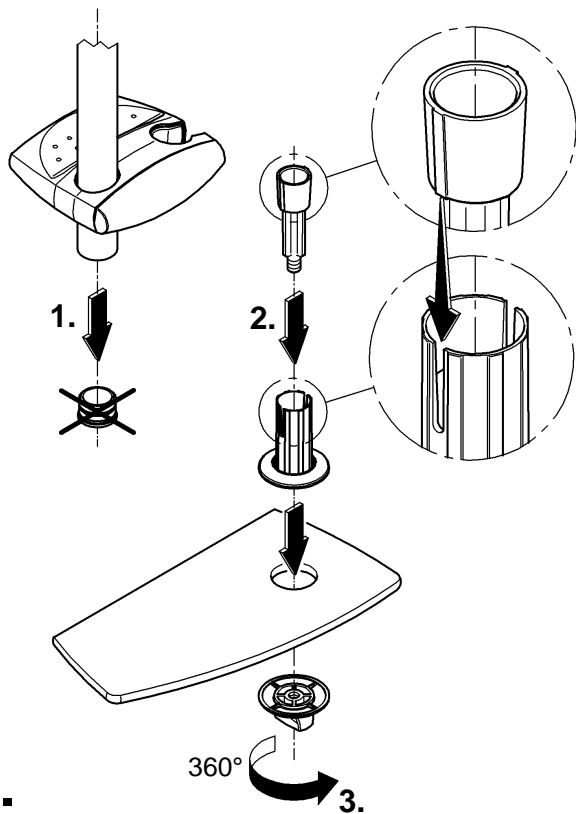