

Wall A

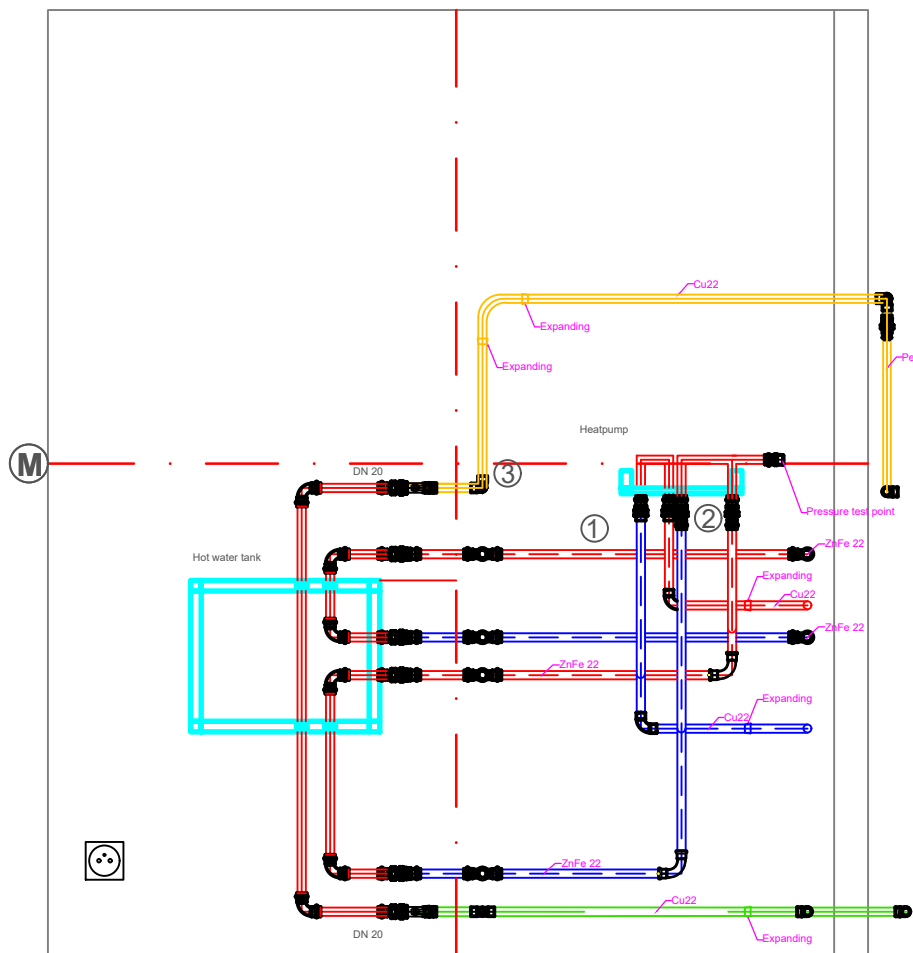

Wall B

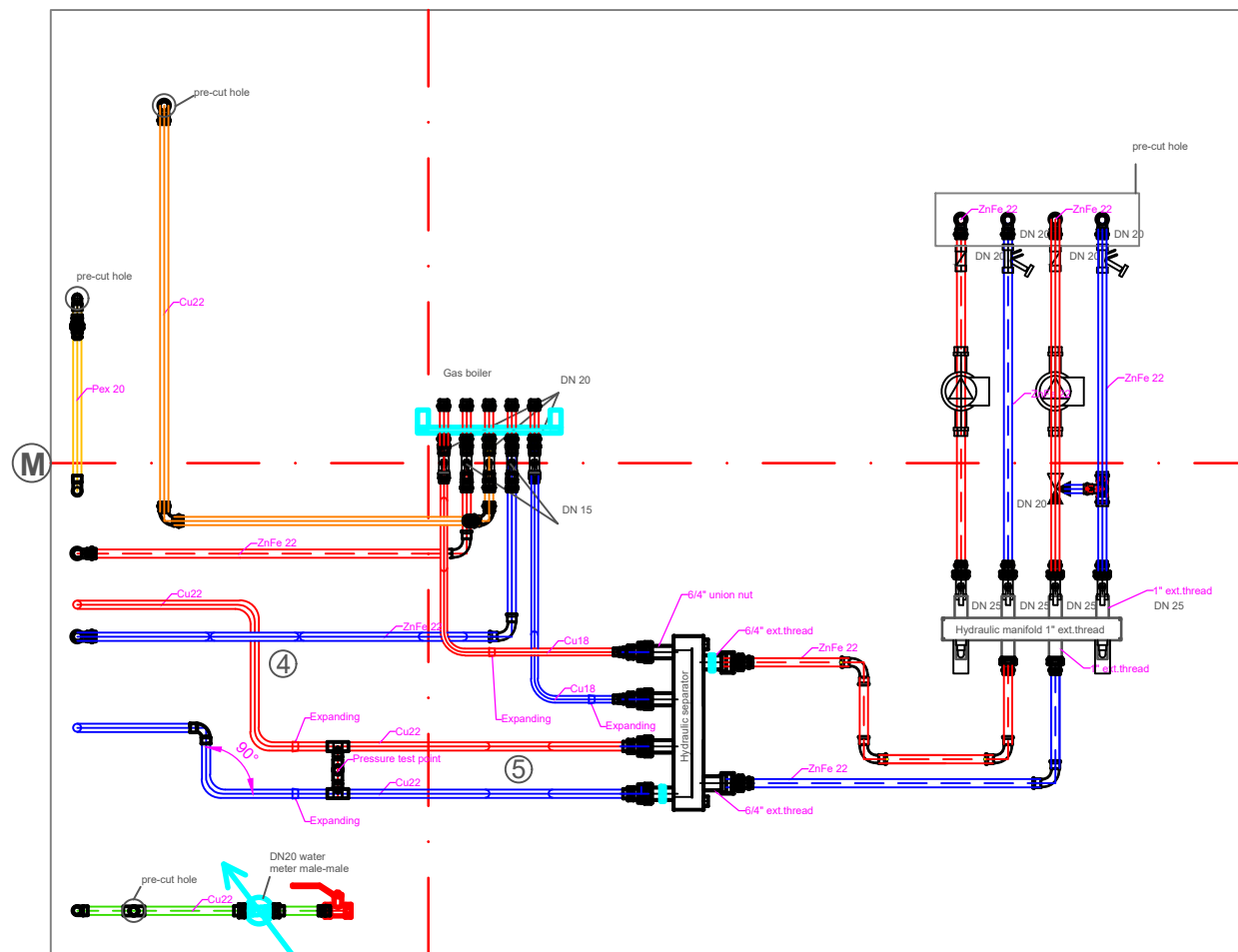

Wall C

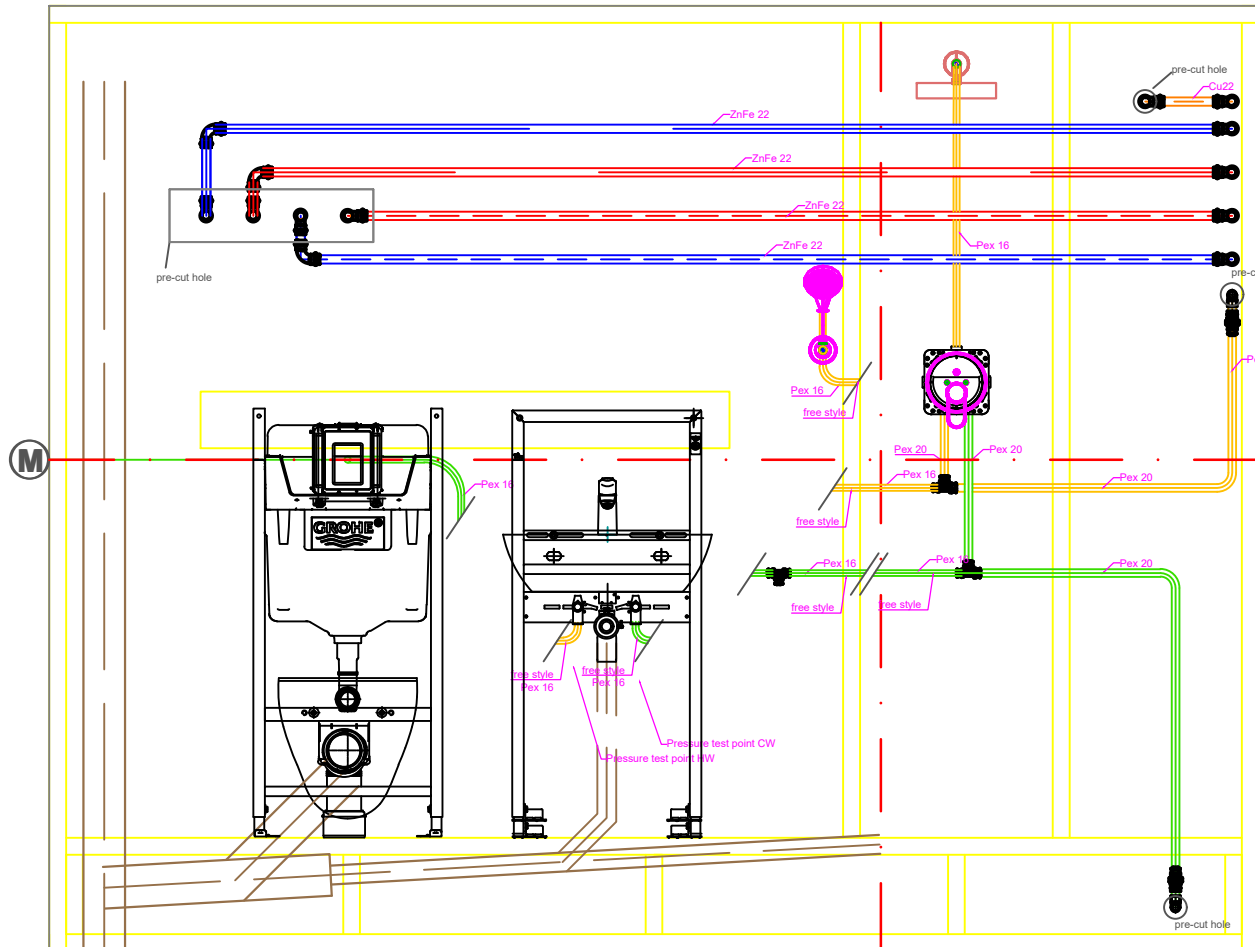

Wall D

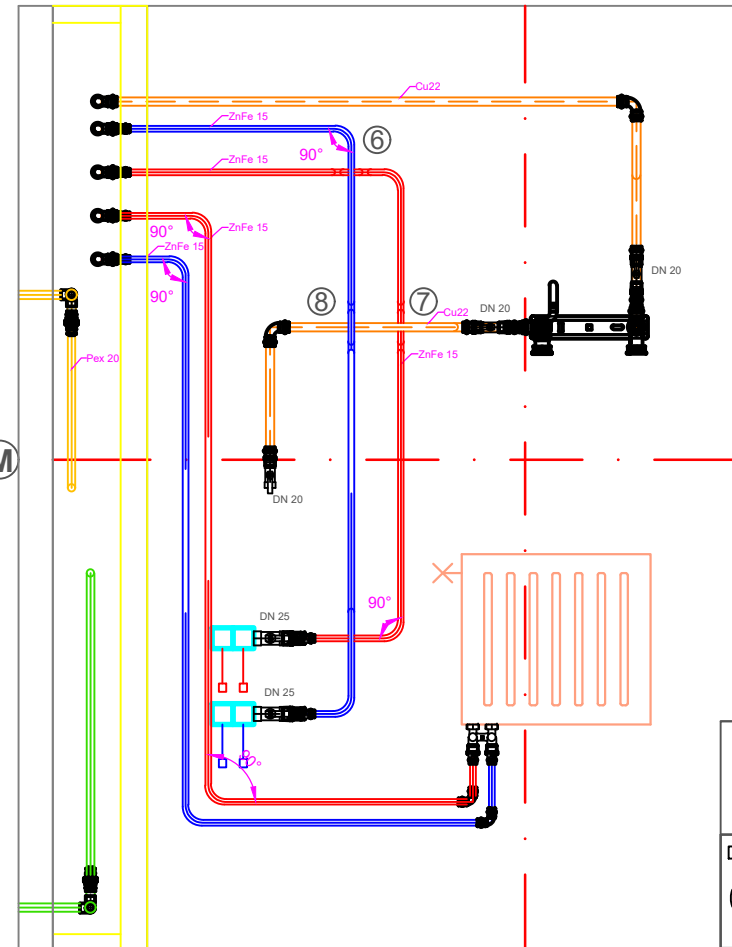

Measurements in millimetres (mm)

	Heating pipes FP flow
	Heating pipes RP return
	Cold water pipes: Cu22, Pex20, Pex16
	Hot water pipes: Cu22, Pex20, Pex16,
	Gas pipe: Cu22
	Waste pipe PP or PVC
ZnFe	C- steel (F1 Presstabo)
Fe	Black steel
Cu	Copper semihard
VA	Stainless steel
MB	Machine bend
JOINTS	Heating pipe = press connection and soft soldering
JOINTS	Gas pipe = press connection
JOINTS	Cold water = soft soldering and crimping
JOINTS	Hot water = soft soldering and crimping

Skill 15 – Plumbing&Heating

8th EUROSKILLS Competition 2023 Gdansk

Designed:
Cs.Szigetvári

Paper size:
A3

Title:

Test Project; General

Scale:
1:20

Time:
18 hours

Date:
06/09/2023

Competitor name:

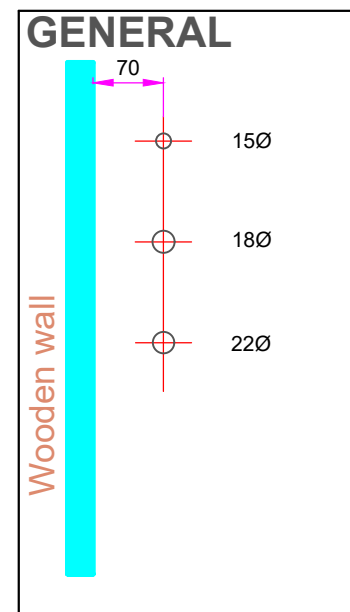
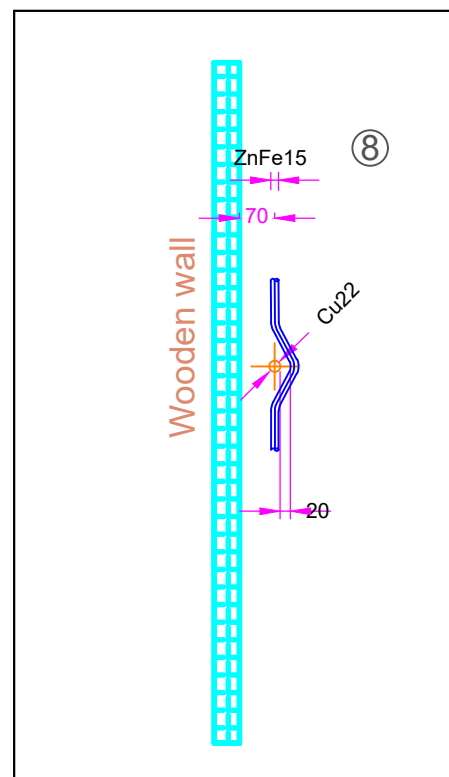
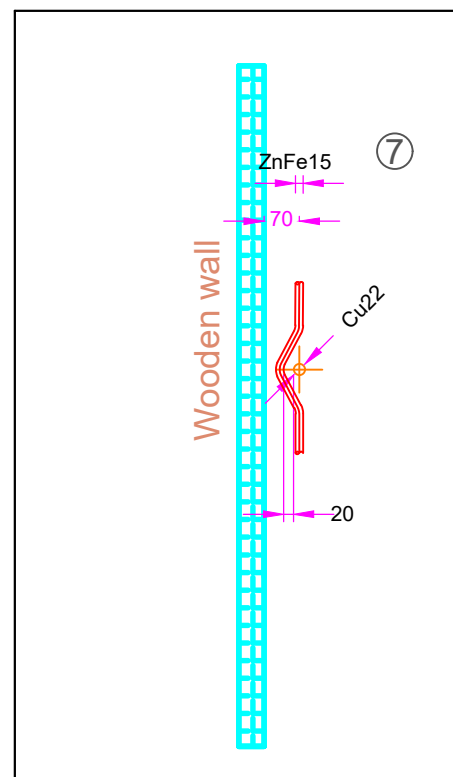
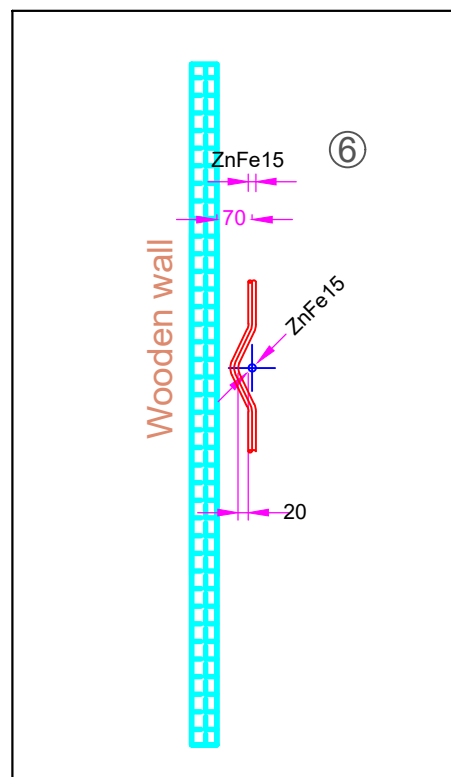
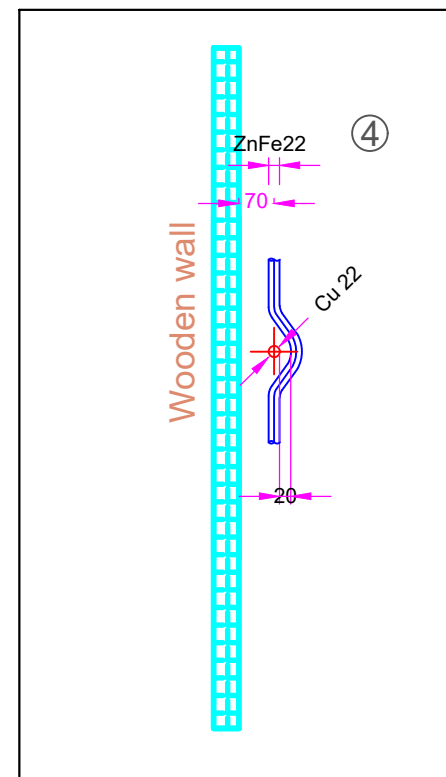
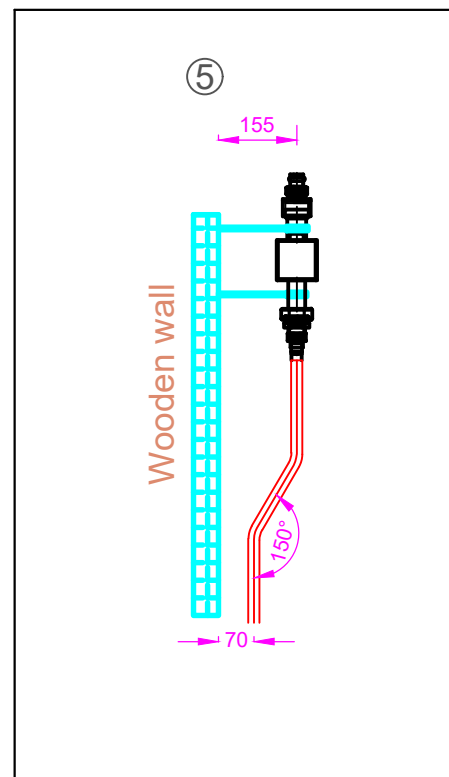
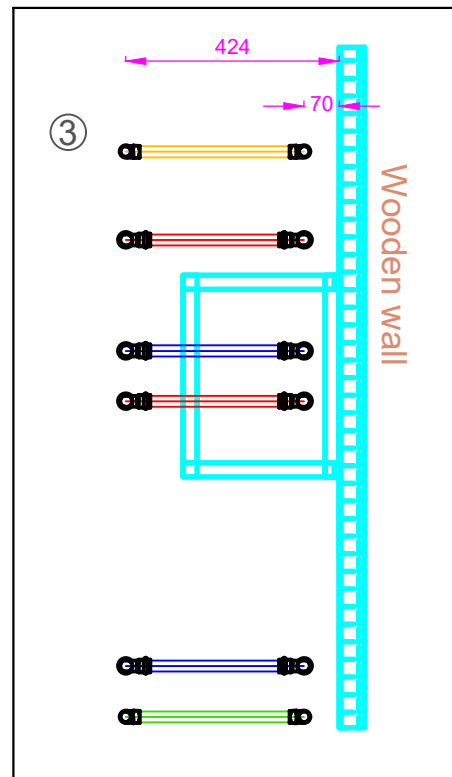
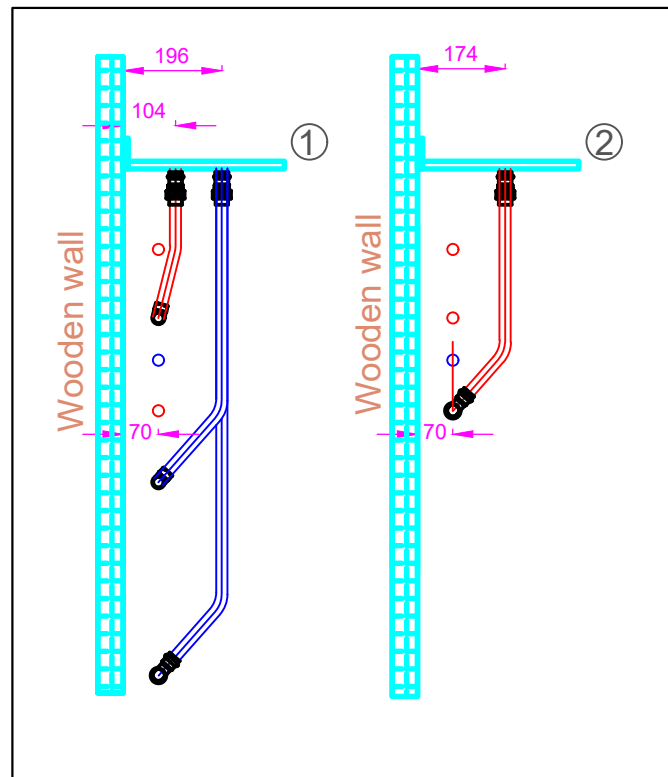

Measurements in millimetres (mm)	
	Heating pipes FP flow
	Heating pipes RP return
	Cold water pipes: Cu22, Pex20, Pex16
	Hot water pipes: Cu22, Pex20, Pex16,
	Gas pipe: Cu22
	Waste pipe PP or PVC
ZnFe	C- steel (F1 Presstabo)
Fe	Black steel
Cu	Copper semihard
VA	Stainless steel
MB	Machine bend
JOINTS	Heating pipe = press connection and soft soldering
JOINTS	Gas pipe = press connection
JOINTS	Cold water = soft soldering and crimping
JOINTS	Hot water = soft soldering and crimping

Skill 15 – Plumbing&Heating		8th EUROSKILLS Competition 2023 Gdansk	
Designed: Cs.Szigetvári	Paper size: A3	Title: Test Project, Details	
Scale: 1:15	Time: 18 hours	Date: 06/09/2023	Competitor name:

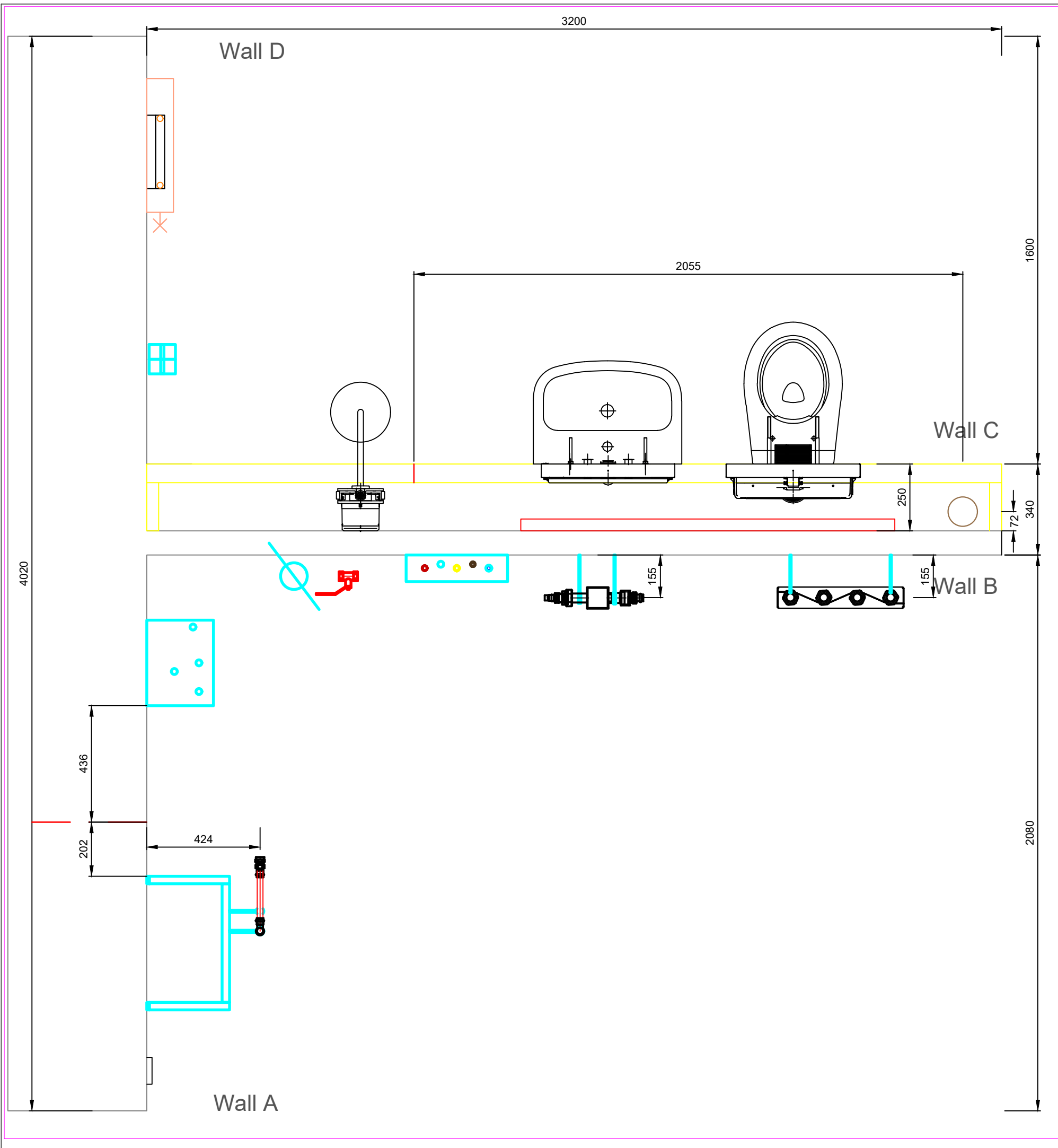

Measurements in millimetres (mm)	
	Heating pipes FP flow
	Heating pipes RP return
	Cold water pipes: Cu22, Pex20, Pex16
	Hot water pipes: Cu22, Pex20, Pex16,
	Gas pipe: Cu22
	Waste pipe PP or PVC
ZnFe	C- steel (F1 Presstabo)
Fe	Black steel
Cu	Copper semihard
VA	Stainless steel
MB	Machine bend
JOINTS	Heating pipe = press connection and soft soldering
JOINTS	Gas pipe = press connection
JOINTS	Cold water = soft soldering and crimping
JOINTS	Hot water = soft soldering and crimping

Skill 15 – Plumbing&Heating		8th EUROSKILLS Competition 2023 Gdansk	
Designed: Cs.Szigetvári	Paper size: A3	Title: Test Project; Floorplan	
Scale: 1:15	Time: 18 hours	Date: 06/09/2023	Competitor name:

Wall A

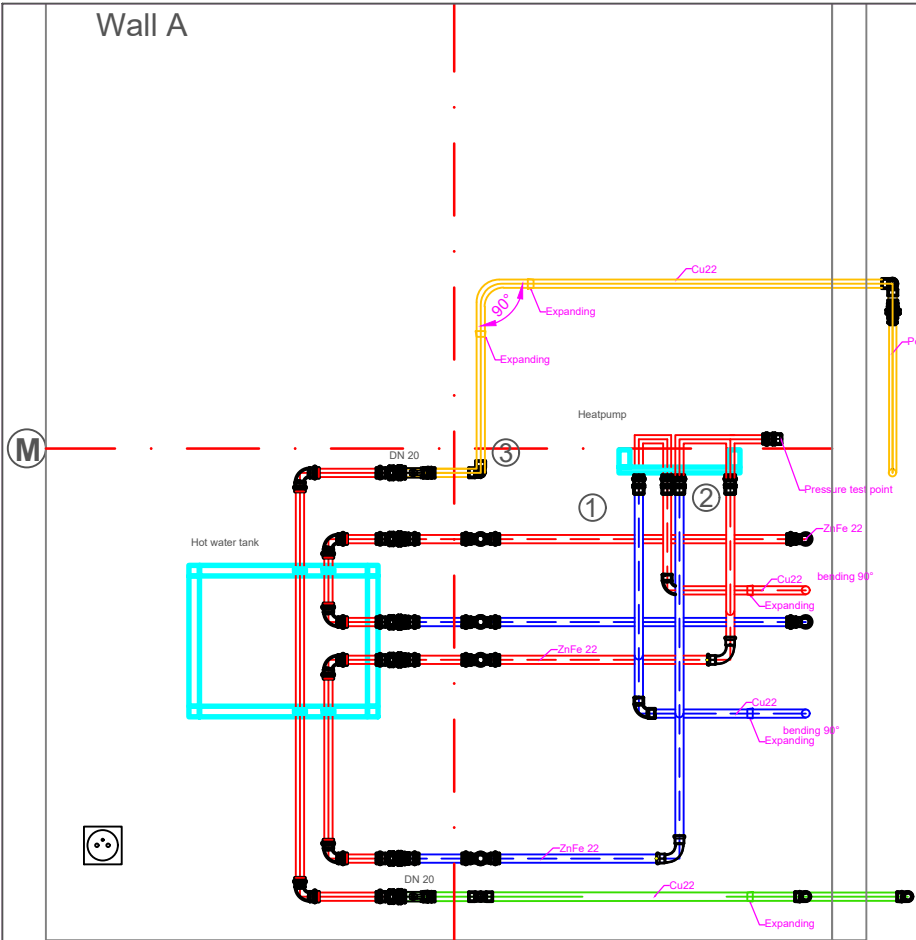

Wall B

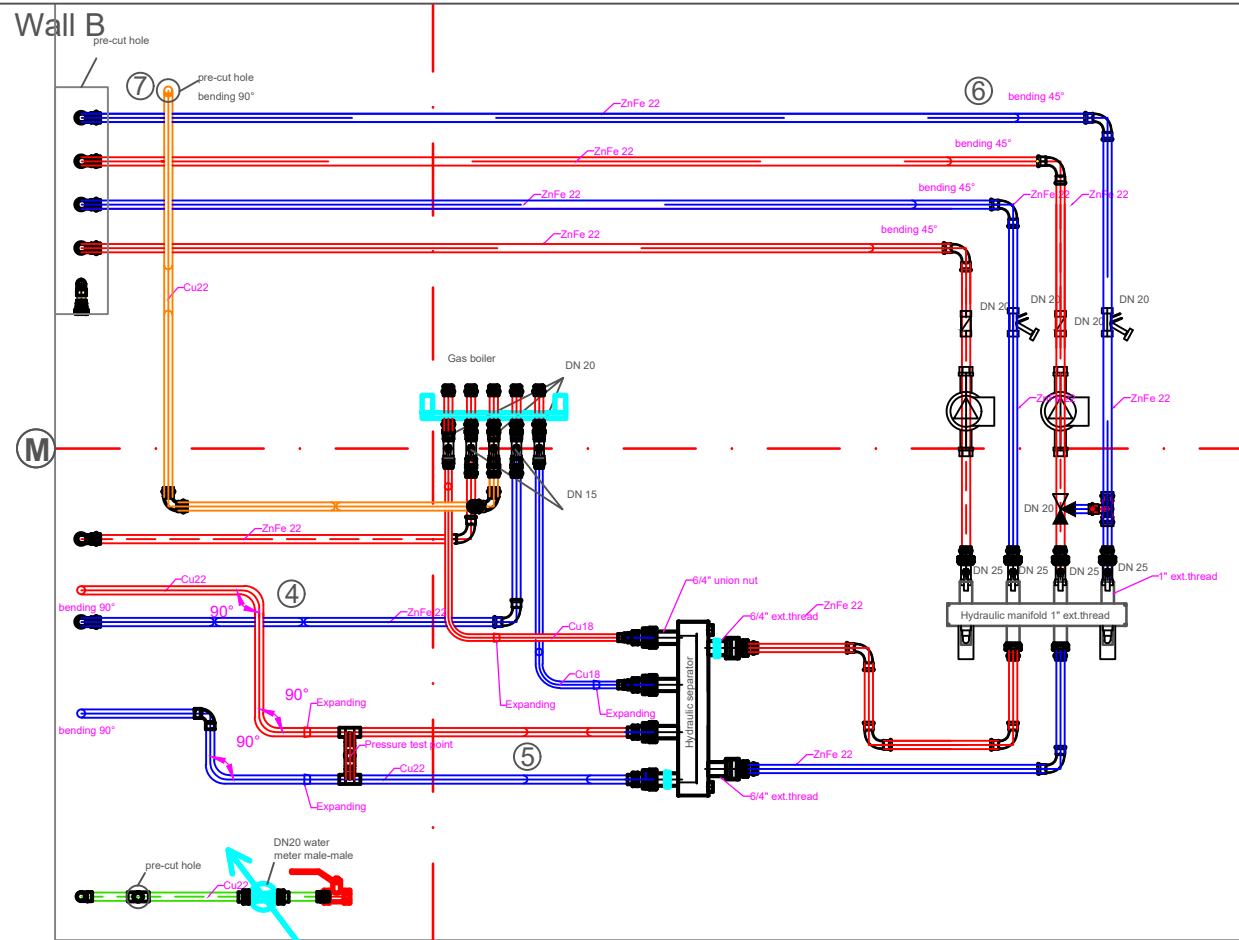

Wall C

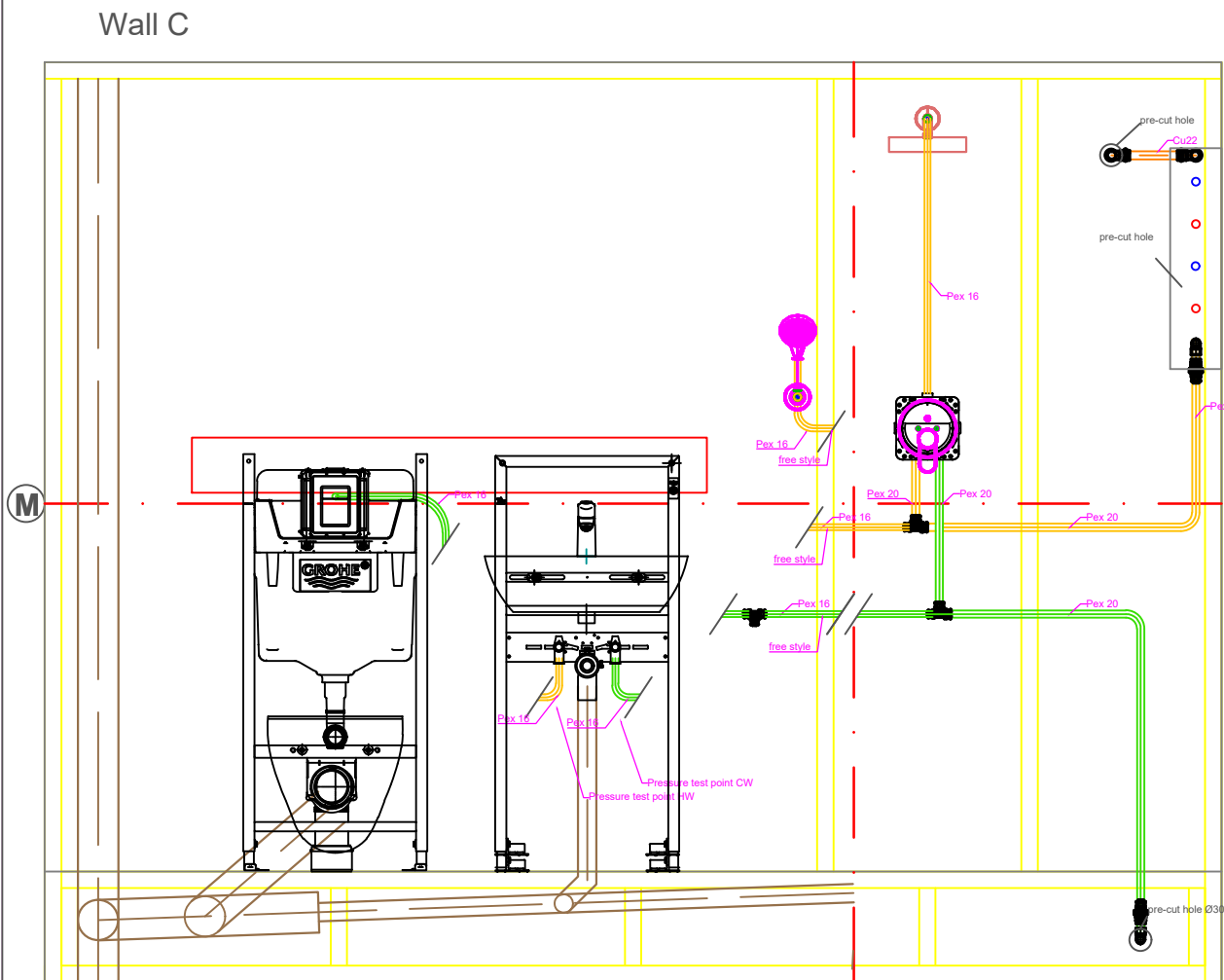

Wall D

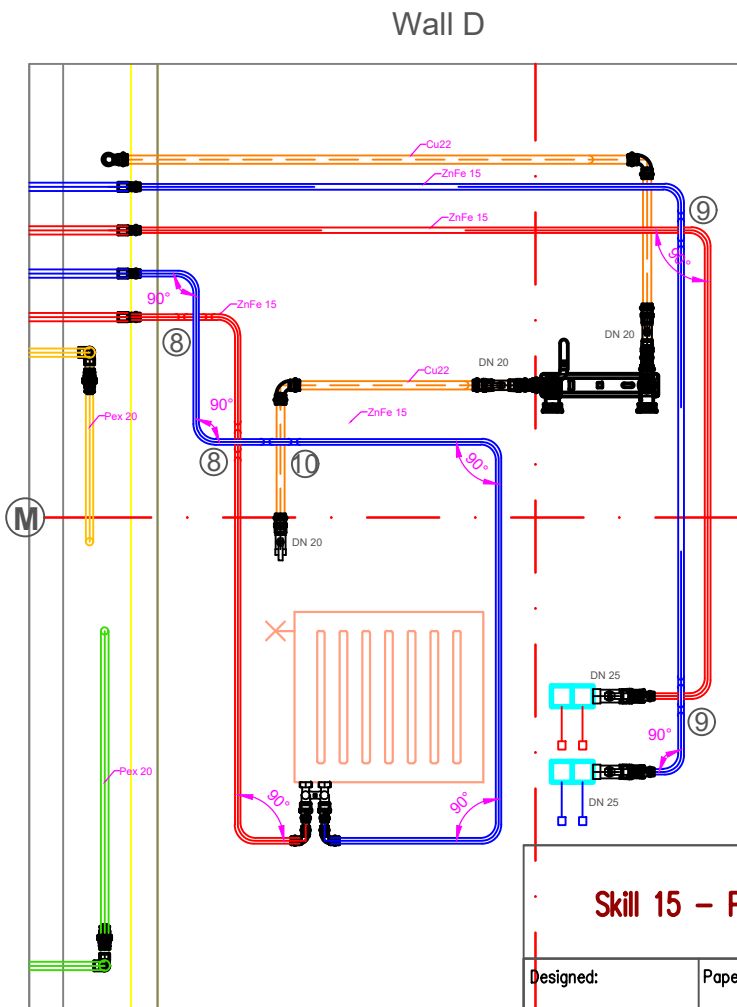

Measurements in millimetres (mm)	
	Heating pipes FP flow
	Heating pipes RP return
	Cold water pipes: Cu22, Pex20, Pex16
	Hot water pipes: Cu22, Pex20, Pex16,
	Gas pipe: Cu22
	Waste pipe PP or PVC
ZnFe	C- steel (F1 Presstabo)
Fe	Black steel
Cu	Copper semihard
VA	Stainless steel
MB	Machine bend
JOINTS	Heating pipe = press connection and soft soldering
JOINTS	Gas pipe = press connection
JOINTS	Cold water = soft soldering and crimping
JOINTS	Hot water = soft soldering and crimping

Skill 15 – Plumbing&Heating

8th EUROSKILLS Competition 2023 Gdansk

Designed:
Cs.Szigetvári

Paper size:
A3

Title:

Test Project; General

Scale:

1:20

Time:

18 hours

Date:

06/09/2023

Competitor name:

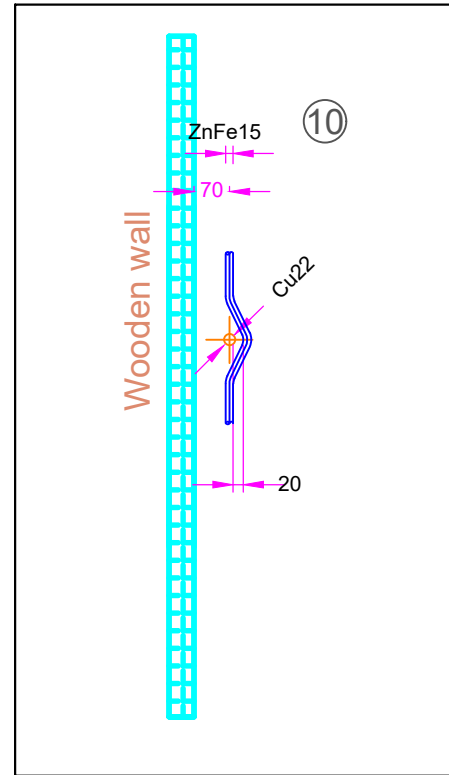
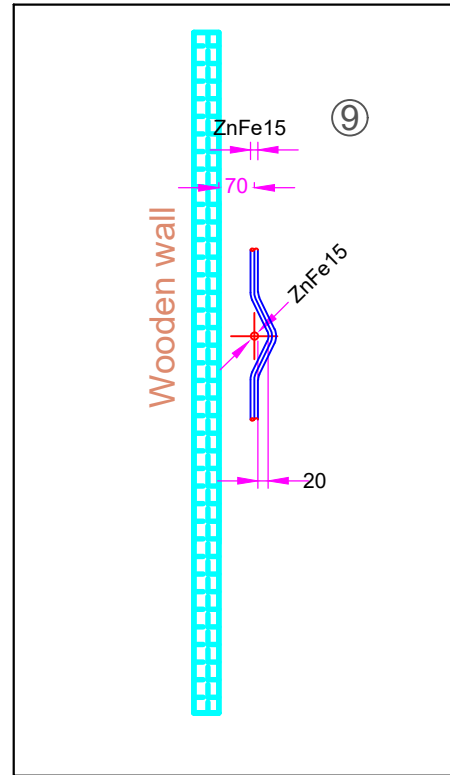
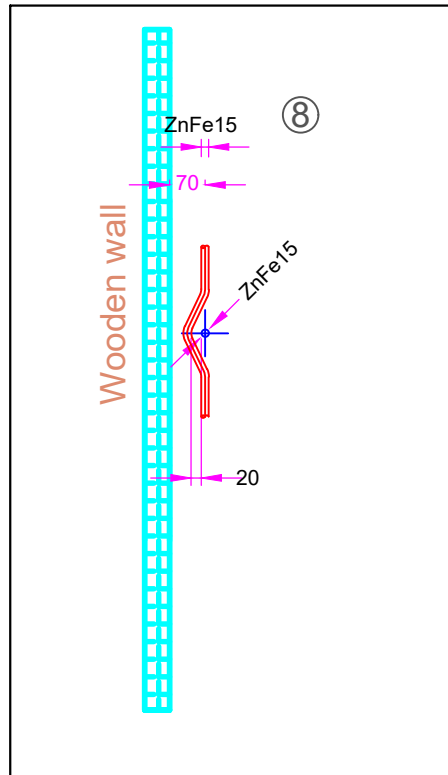
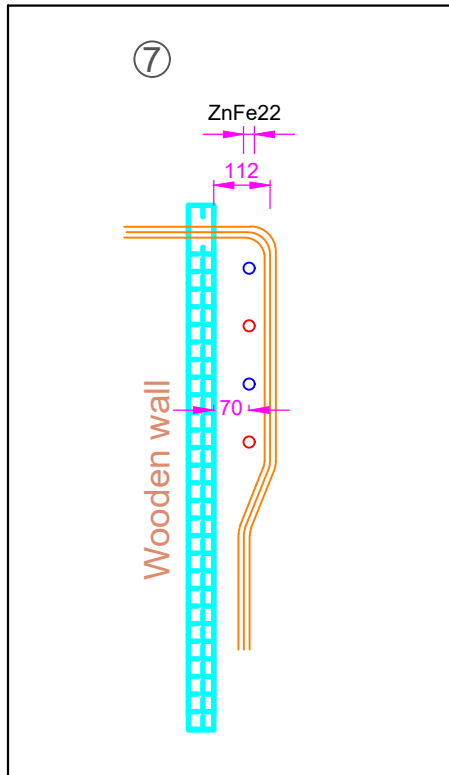
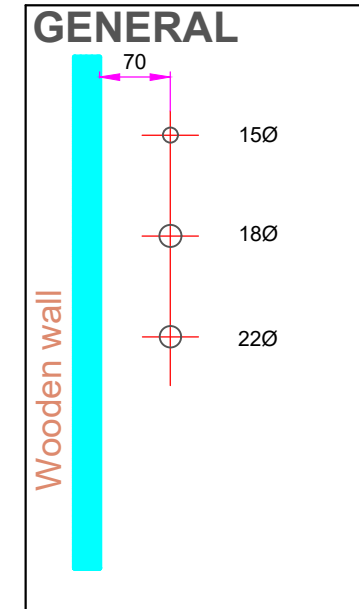
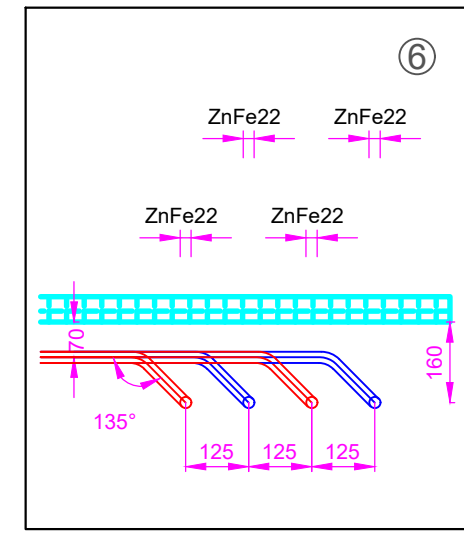
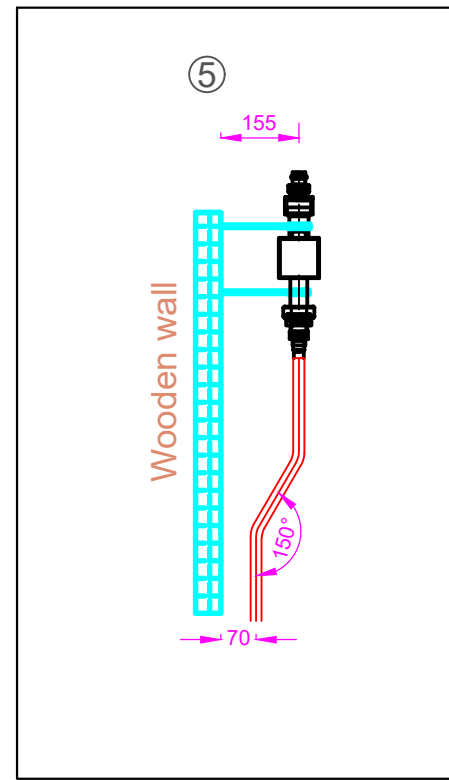
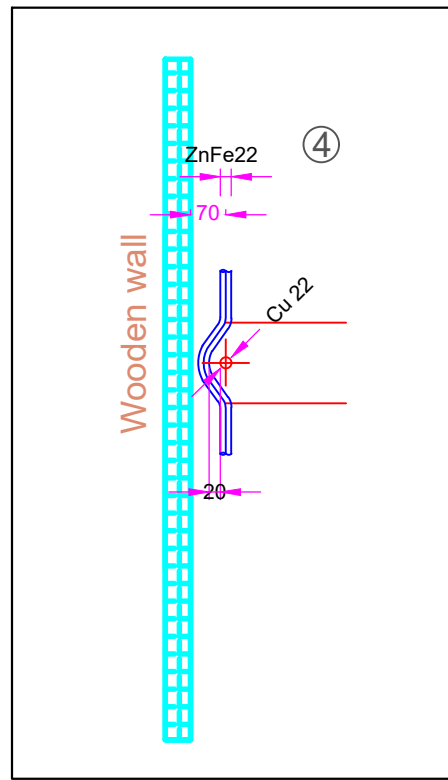
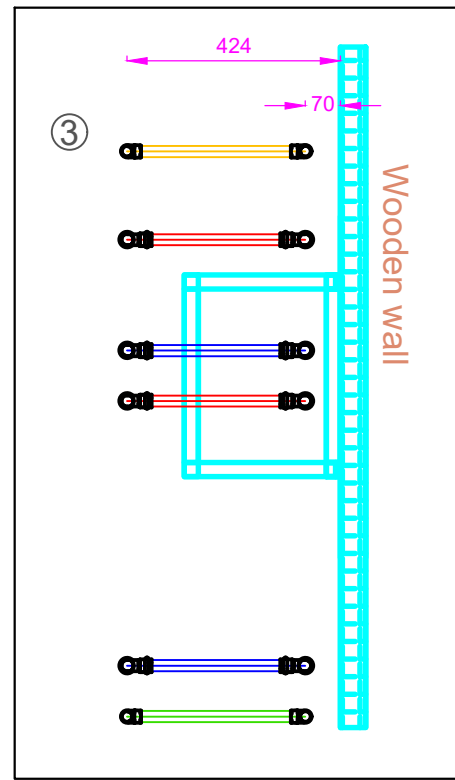
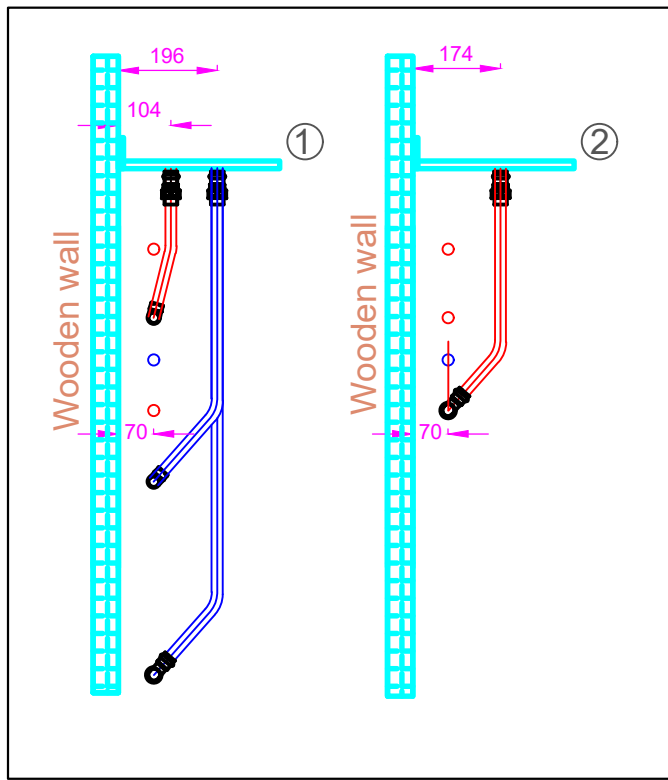

Skill 15 – Plumbing&Heating		8th EUROSKILLS Competition 2023 Gdansk	
Designed: Cs.Szigetvári	Paper size: A3	Title: Test Project; Details	
Scale: 1:15	Time: 18 hours	Date: 06/09/2023	Competitor name:

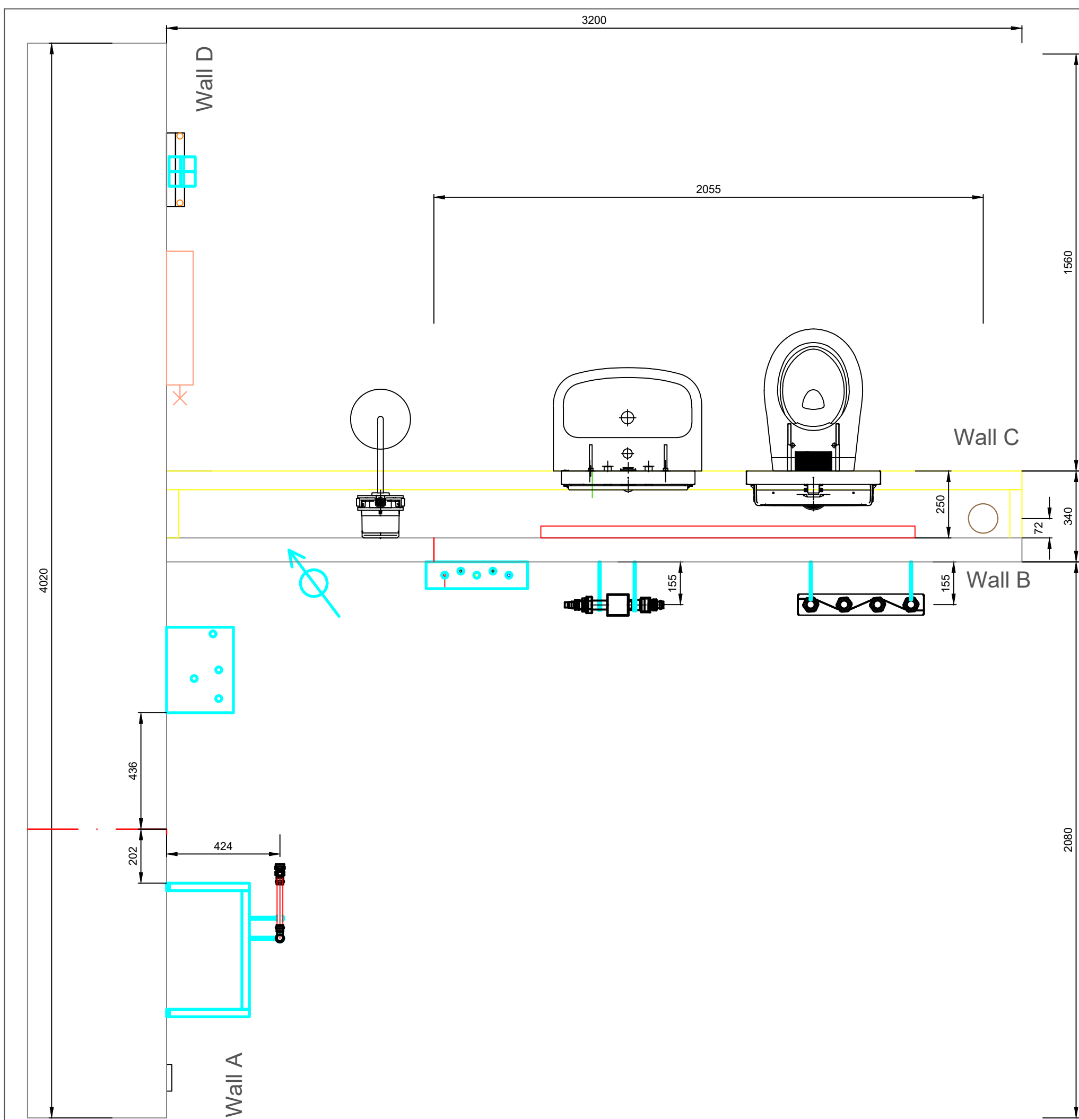

Skill 15 – Plumbing&Heating		8th EUROSILLS Competition 2023 Gdansk	
Designed: Cs.Szigetvári	Paper size: A3	Title: Test Project; Floorplan	
Scale: 1:15	Time: 18 hours	Date: 06/09/2023	Competitor name:

Wall A

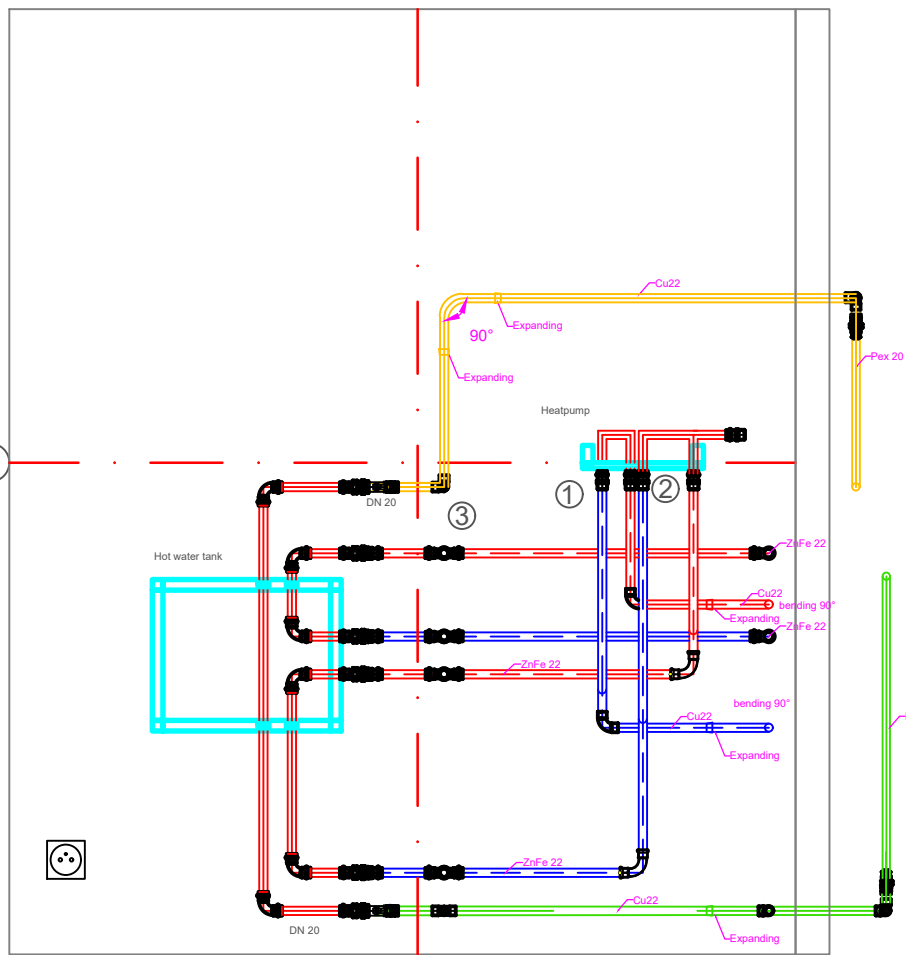

Wall B

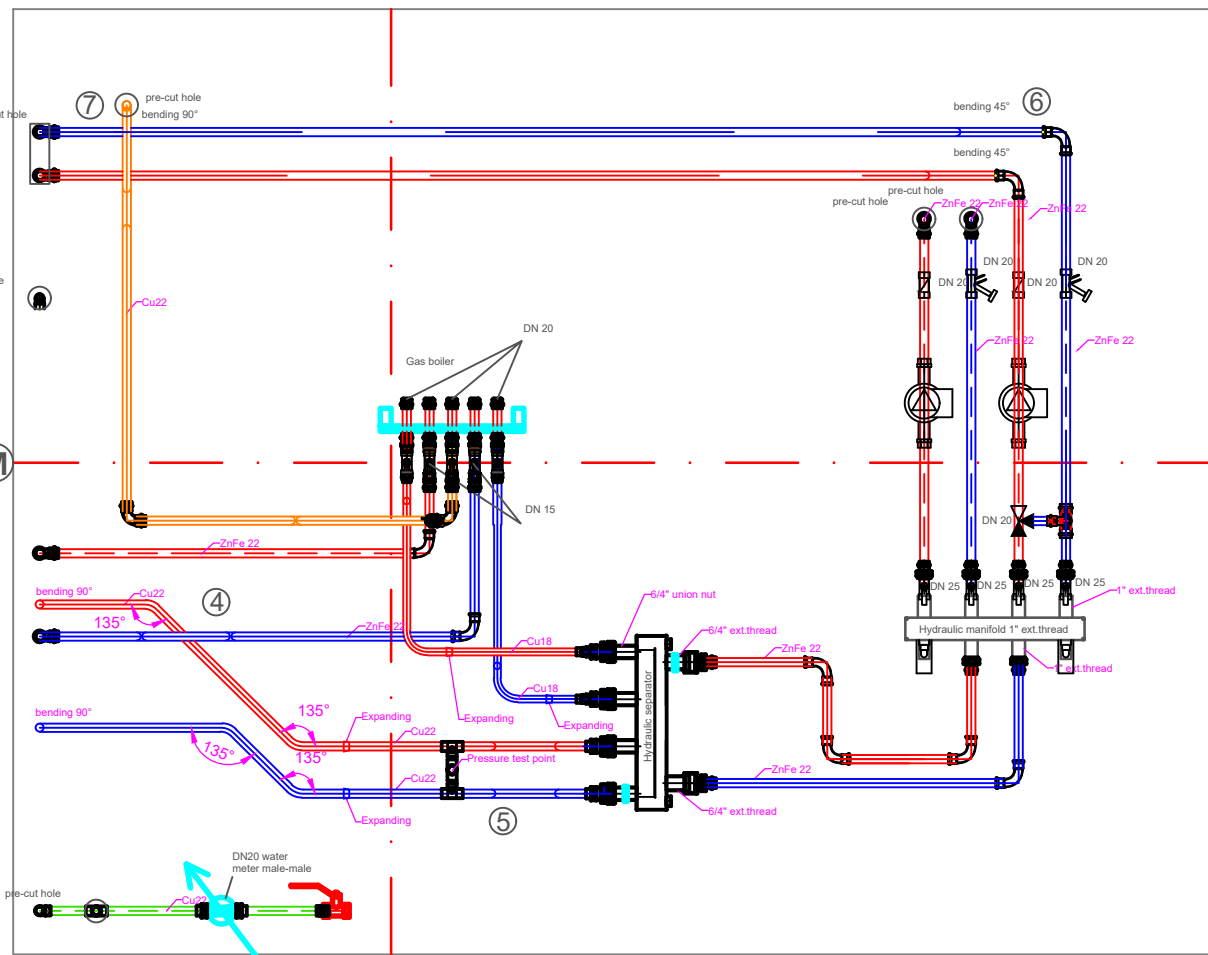

Wall C

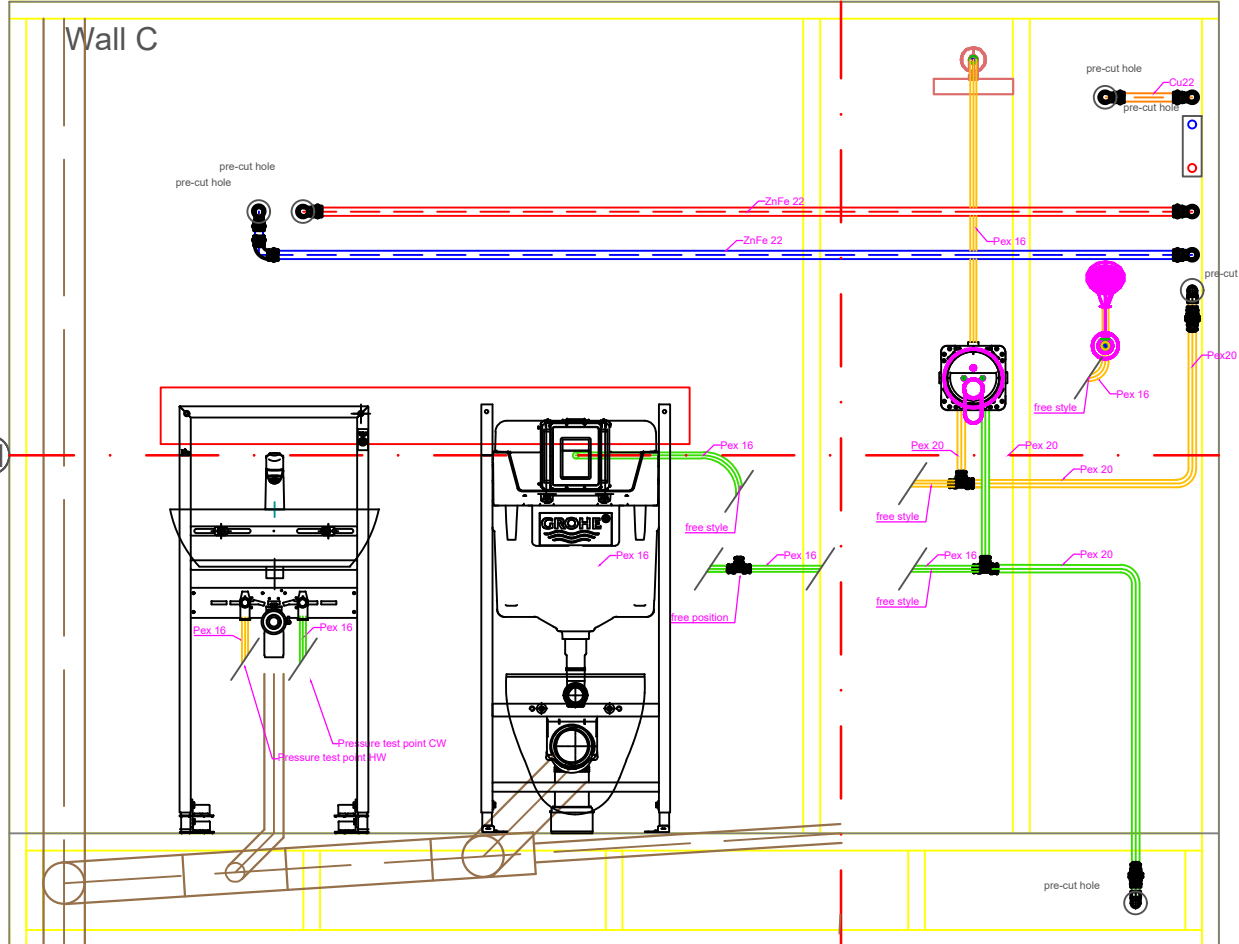

Wall D

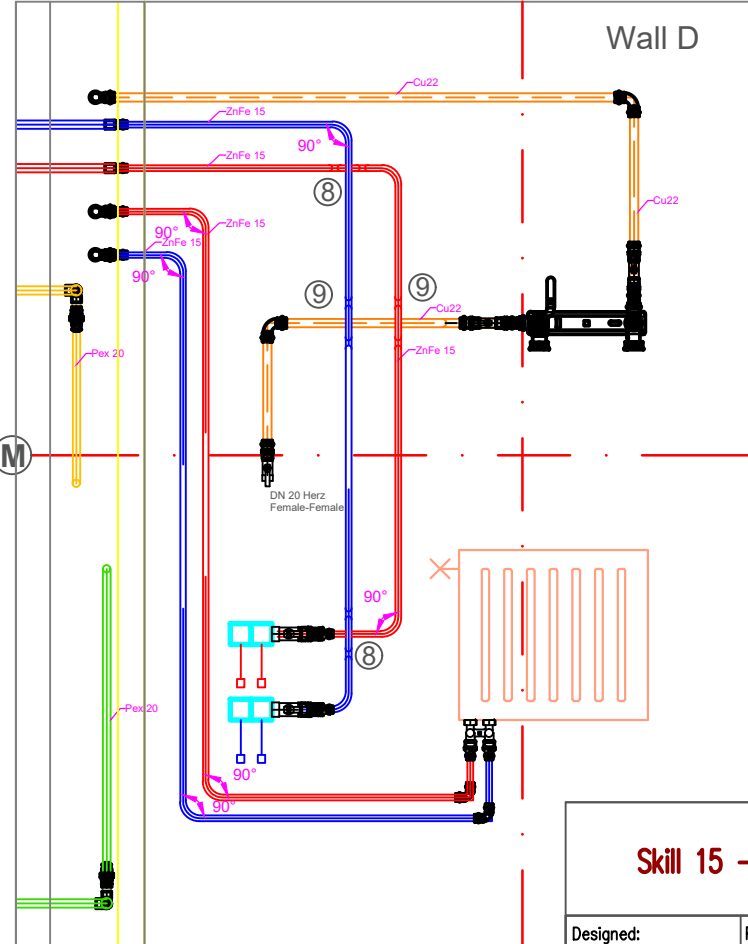

Measurements in millimetres (mm)

	Heating pipes FP flow
	Heating pipes RP return
	Cold water pipes: Cu22, Pex20, Pex16
	Hot water pipes: Cu22, Pex20, Pex16,
	Gas pipe: Cu22
	Waste pipe PP or PVC
ZnFe	C- steel (F1 Presstabo)
Fe	Black steel
Cu	Copper semihard
VA	Stainless steel
MB	Machine bend
JOINTS	Heating pipe = press connection and soft soldering
JOINTS	Gas pipe = press connection
JOINTS	Cold water = soft soldering and crimping
JOINTS	Hot water = soft soldering and crimping

Skill 15 – Plumbing & Heating

8th EUROSKILLS Competition 2023 Gdansk

Designed:	Paper size:	Title:	
Cs.Szigetvári	A3		Test Project; General
Scale:	Time:	Date:	Competitor name:
1:20	18 hours	06/09/2023	

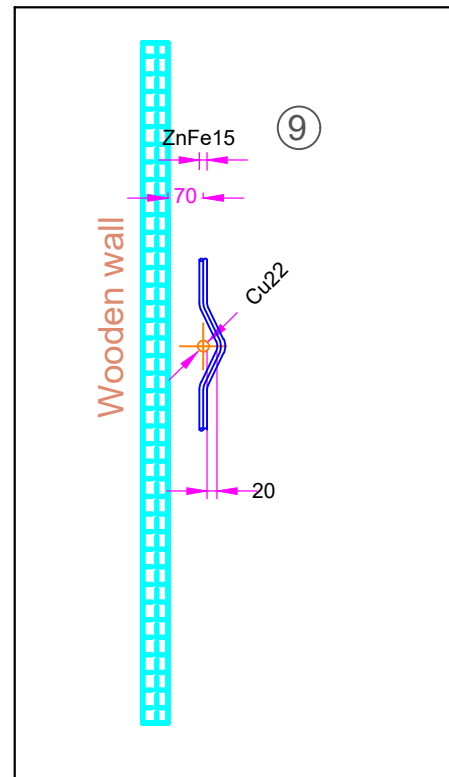
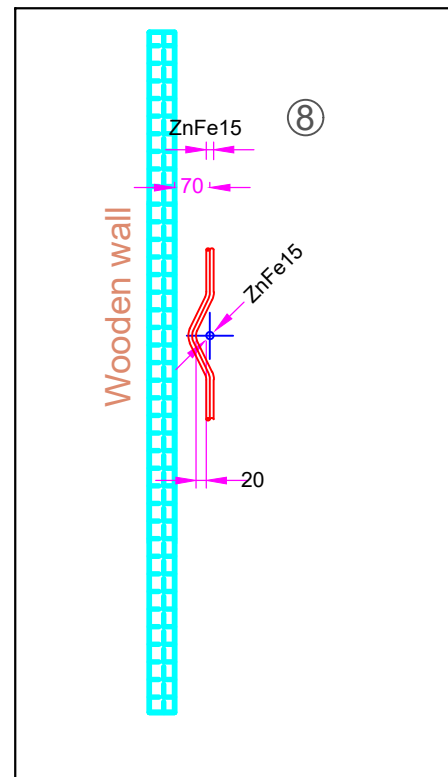
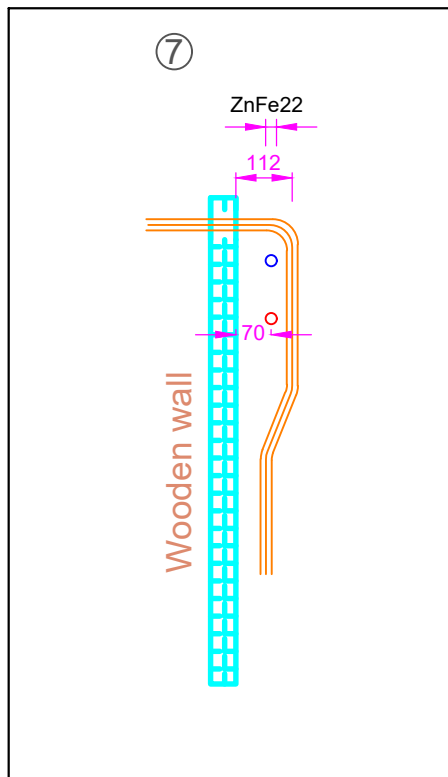
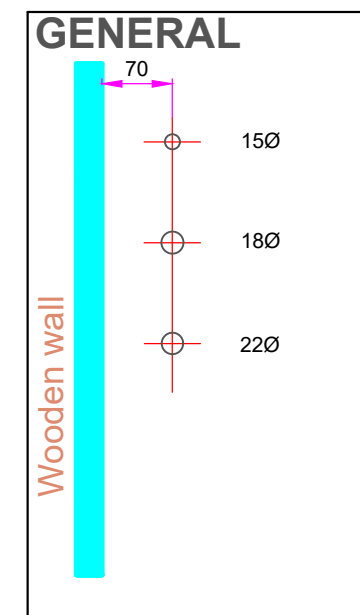
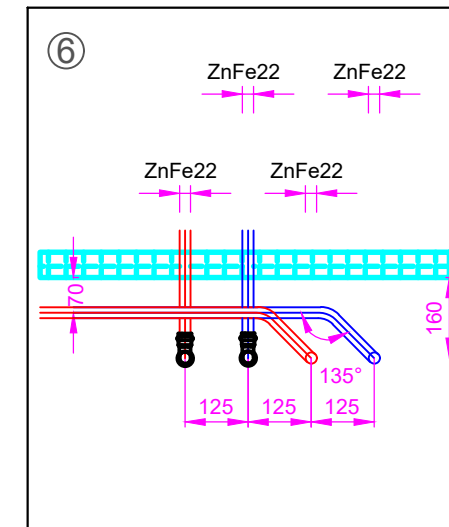
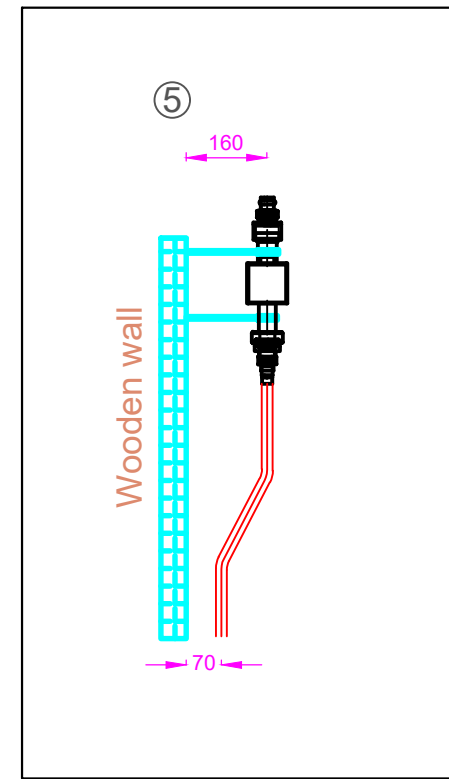
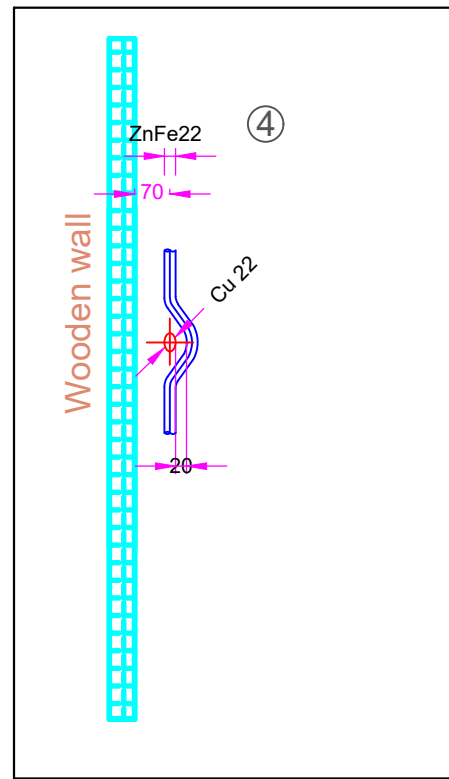
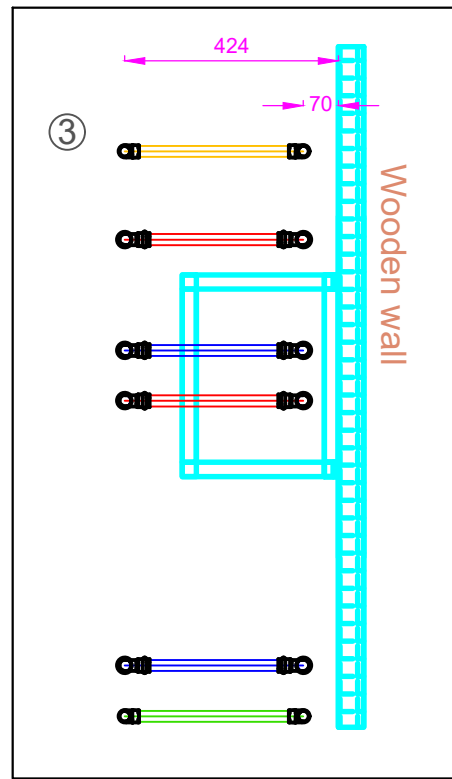
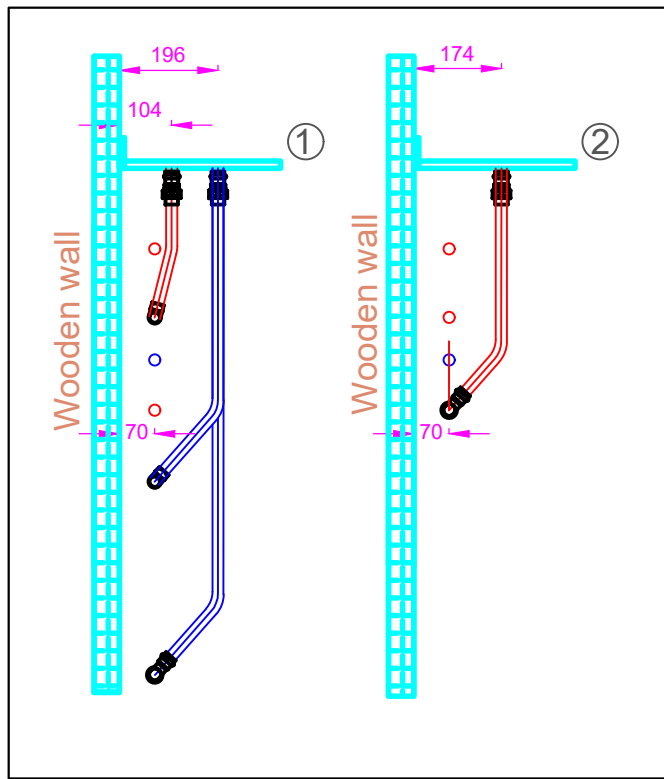

Skill 15 – Plumbing&Heating		8th EUROSILLS Competition 2023 Gdansk	
Designed: Cs.Szigetvári	Paper size: A3	Title: Test Project; details	
Scale: 1:15	Time: 18 hours	Date: 06/09/2023	Competitor name:

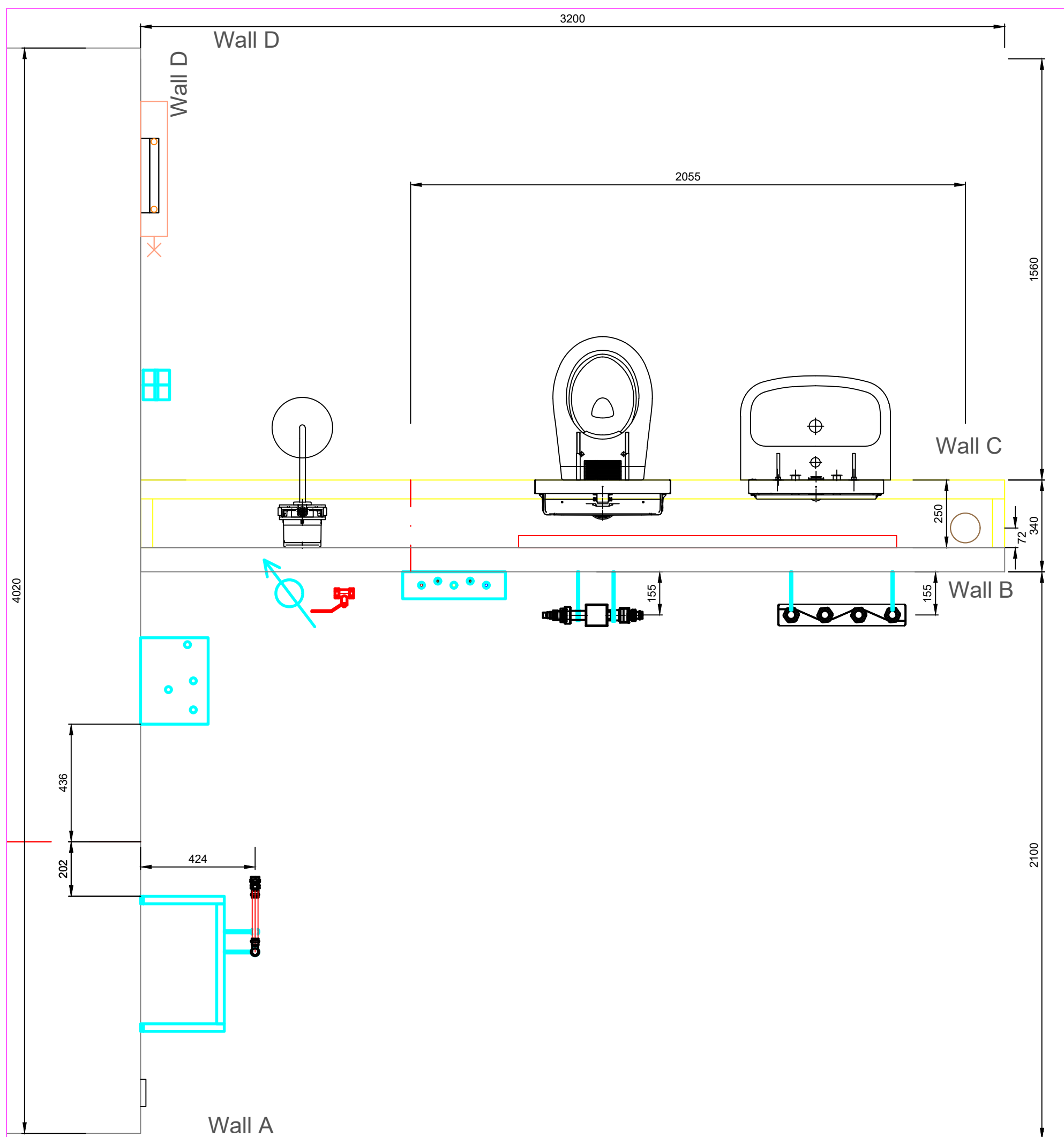

Measurements in millimetres (mm)	
	Heating pipes FP flow
	Heating pipes RP return
	Cold water pipes: Cu22, Pex20, Pex16
	Hot water pipes: Cu22, Pex20, Pex16,
	Gas pipe: Cu22
	Waste pipe PP or PVC
ZnFe	C- steel (F1 Presstabo)
Fe	Black steel
Cu	Copper semihard
VA	Stainless steel
MB	Machine bend
JOINTS	Heating pipe = press connection and soft soldering
JOINTS	Gas pipe = press connection
JOINTS	Cold water = soft soldering and crimping
JOINTS	Hot water = soft soldering and crimping

Skill 15 – Plumbing&Heating		8th EUROSILLS Competition 2023 Gdansk	
Designed: Cs.Szigetvári	Paper size: A3	Title: Test Project; Floorplan	
Scale: 1:15	Time: 18 hours	Date: 06/09/2023	Competitor name: