

Pure Freude
an Wasser



p. 4
The need
to save water

p. 10
Save energy
now

p. 16
Less waste,
more longevity

p. 22
Building
sustainability

p. 28
Smart
processes

p. 34
Social
responsibility

WATER ENJOYMENT –
WITH A CLEAN CONSCIENCE
GROHE SUSTAINABILITY



Winner 2017



“For the third year in a row, GROHE has been ranked as one of Germany’s most sustainable companies. We are also the first company in our sector to win the German government’s Corporate Social Responsibility Award 2017. Sustainability is embedded in our everyday business and is an integral part of our GROHE Brand DNA.”



Winner 2017



OUR JOY OF WATER

OUR PASSION

FOR SUSTAINABILITY

Water is the essential element that makes our bathroom rituals so special. So personal. So enjoyable. That's why GROHE is proud to help everyone experience the pure joy of water. But drinkable water is also becoming increasingly rare. That's why GROHE has a burning passion to save every drop we can. It's a passion that has already, over several decades, created numerous sustainability solutions. And each solution has intensified our passion, spurring us on to the next level of finding water- and energy-saving technologies. It is no surprise, then, that GROHE considers sustainability to be one of its core brand values, alongside technology, quality and design.

What's more, like any passion, it's contagious. Throughout our organisation there are people sparking ideas, developing initiatives and deploying new ways to save water and energy. To recognise these activities, in 2011 we implemented the GROHE SustainAbility Trophy, an internal competition between our production sites, to encourage continuous optimisation of sustainable processes and to honour people who improve sustainability.

But most importantly, we have set ourselves an important mission: by 2020 GROHE will be the company with the most sustainable practices in the sanitary industry worldwide. Together with our "Made in Germany" reputation we can champion the cause of sustainability for all industries.

Our passion for sustainability is so energetic, it spills over and inspires our market partners – both upstream and downstream from our own operations. Everywhere, there are people enthused with the passion to save water, energy and materials.

Our passion has taken us a long way, and tomorrow brings us new opportunities, which we not only aim to seize but also to show others how we do it profitably. That's because ensuring well-being for future generations is best achieved when sustainability also makes economic sense. We have set ourselves the target to make GROHE the reference standard and an inspiration beyond our industry, as the single most sustainable German brand across all industries. At GROHE, tomorrow is looking bright.

The following pages celebrate our passion: a passion that will continue to drive us into the future."

Kind regards,
Michael Rauterkus
 CEO Grohe AG

THE NEED TO **SAVE WATER**

+++ By 2050, 55% more drinkable water will be needed globally. +++ The World Economic Forum already ranks water crisis as the top global risk. +++ We can all save drops today, accumulating oceans tomorrow.



SAVING WATER ONE DROP AT A TIME

IT'S NOW OR NEVER

By 2050, the people of our planet will need 55% more drinkable water than we have today. Already one third of the world's population now lives in water-stressed areas, and nearly a billion people live without access to drinkable water. On top of all this, we are experiencing increasing drought in some of the world's most productive farmlands.

These are the sobering findings of the World Economic Forum's "Global Risks 2015" report. It is the fourth time water has made the annual list of most threatening risks to economies, environments and people, and the first time that water has moved into the top position.

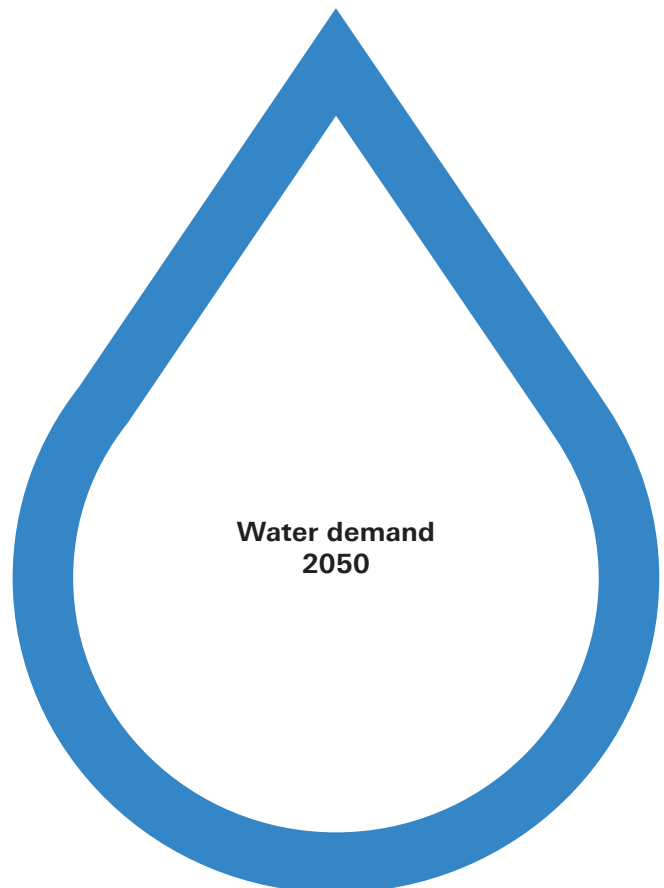

LESS IS MORE

We can all save a few drops of water each day. For example, simply turning the faucet off when we brush our teeth will save six litres every minute. We should always use full loads in our washing machines and dishwashers to reduce the total number of washes. And we can repair dripping faucets, which can waste 15 litres of water every day. That's about 5,500 litres a year.

Also, because 14% of all wasted water is caused by undetected leakage, digital technology is soon expected to make savings in this vital area, too.

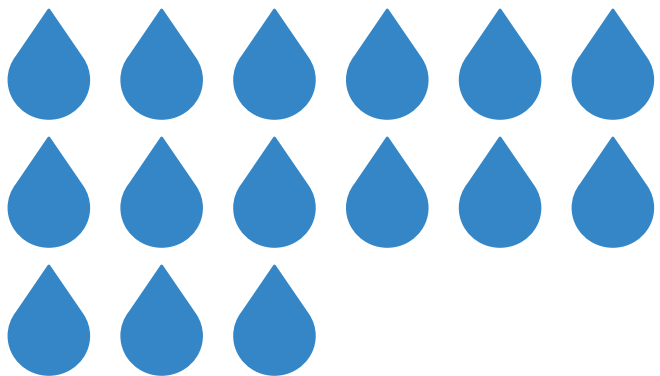

Repairing dripping faucets can save 15 litres of water every day



Turning the faucet off when we brush our teeth will save six litres every minute

OUR MISSION AT GROHE: **WATER-SAVING TECHNOLOGIES**

We have developed a line of smart water-saving products that use less water but do not reduce the enjoyment of the experience. GROHE EcoJoy faucets, for example, use a flow-limiting mousseur to reduce water consumption from 10 litres per minute to just over five litres. But because GROHE EcoJoy faucets also have an aerator, the user experiences the same voluminous flow as that given by a regular faucet. We also have infrared sensors built into faucets, so water flows only when hands are underneath the tap. And our toilets can come with concealed dual-flush cisterns or start/stop systems to minimise water usage.



Concetto, S-Size,
with GROHE EcoJoy

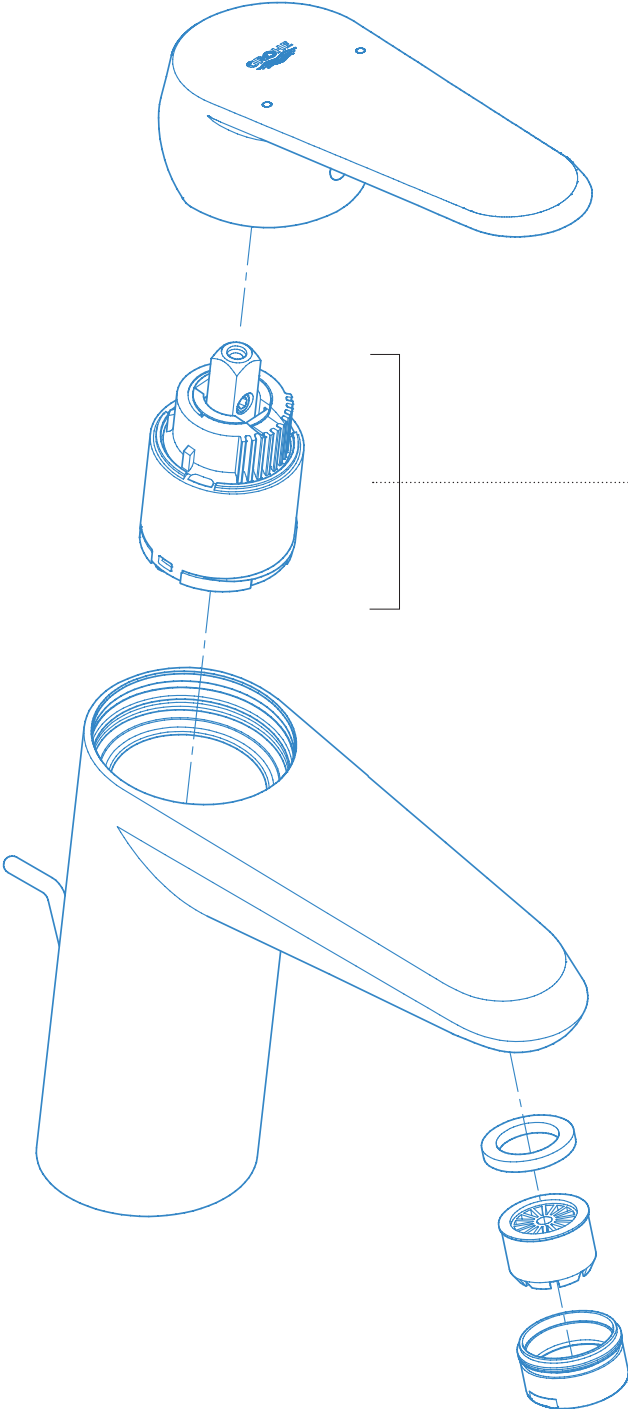

Our GROHE EcoJoy faucets use a flow restrictor to reduce water consumption from 10 litres per minute to just over five litres.

An aerator provides the same voluminous experience as that offered by a regular faucet.



GROHE ECOJOY
Save precious resources and enjoy 100 % water comfort.

SAVE ENERGY **NOW**

+++ Swelling populations and accelerating economies crave for more energy every day. +++ The UN believes this could badly strain Earth's limited resources. +++ We can all save energy today, with slight behaviour changes.



BRIGHT WAYS TO SAVE ENERGY

WE'RE IN THIS TOGETHER

Amid the world's swelling populations and accelerating economies, the demand for energy will intensify in the near future. And, according to the UN, this increased demand could severely deplete the Earth's limited resources. What's more, obtaining water requires energy, and producing energy requires water, so a holistic solution – one that addresses all factors – is essential.



**20% of the world's
population...**

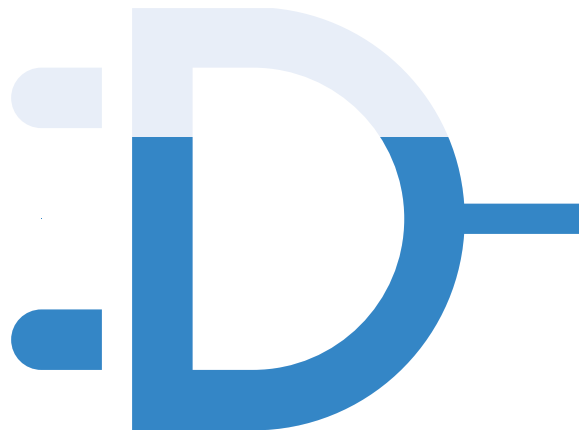

**...is using 70%
of the world's energy**

SAVING ENERGY BY DEGREES

Every time we draw hot water we consume energy, so it makes sense to use it wisely. Other slight changes in our behaviour can also save energy; for example, switching off gadgets on standby can save up to 10% off our fuel bills. Running our washing machines on cold water programmes also saves energy. More savings may be achieved by shutting doors and closing curtains properly to keep heat in, and simply wearing the right clothes to keep warm rather than turning up the central heating – every degree above 20°C can add 10% to our bill. So we should think twice before adjusting the thermostat.

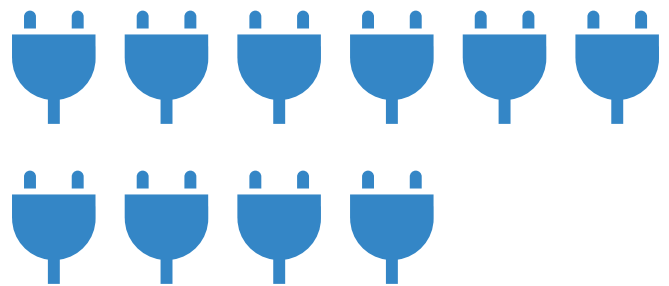

Central heating at 20°C

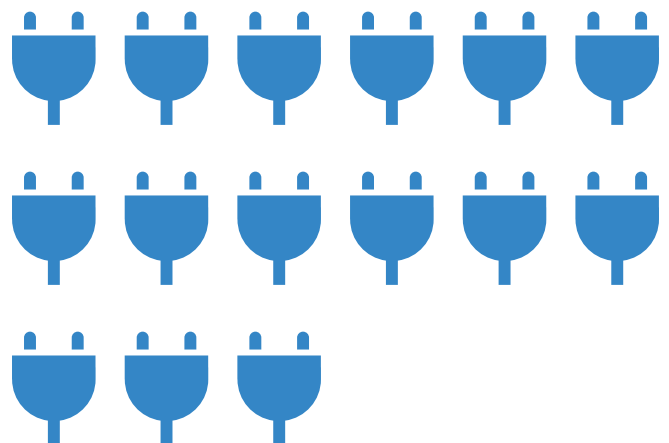

Central heating at 25°C

OUR MISSION AT GROHE: **ENERGY-SAVING TECHNOLOGIES**

In addition to water-saving features, we have also developed a line of energy-saving products.

GROHE SilkMove ES, for example, saves energy by supplying cold water with the faucet lever in the middle position of the fitting. In this way it prevents unnecessary production of hot water and also helps to ensure that drawn water is never hotter than intended. Thanks to special cartridge features, such as high-quality ceramic discs and Teflon® technology, the GROHE SilkMove ES also offers a uniquely smooth operation which results in a lifetime of effortless precision.

We also help save energy with advanced thermostats. For example, GROHE TurboStat technology provides the desired shower temperature in the fastest possible and most comfortable way. Firstly, this saves water and time since cold water inflow is diminished during the warm-up phase. In addition, due to the active control mechanism, GROHE TurboStat keeps the water temperature constant for the duration of the shower which prevents the need for undesired manual adjustments and therefore also saves energy and water.

Another further key aspect of thermostats is the safety feature with antiscald protection.

Another smart, energy-saving idea is our GROHE PowerBox which uses the flow of in-pipe water to generate the electrical energy needed to run an infrared sensor. The sensor detects when hands are removed from the water flow and then instantly closes the faucet.

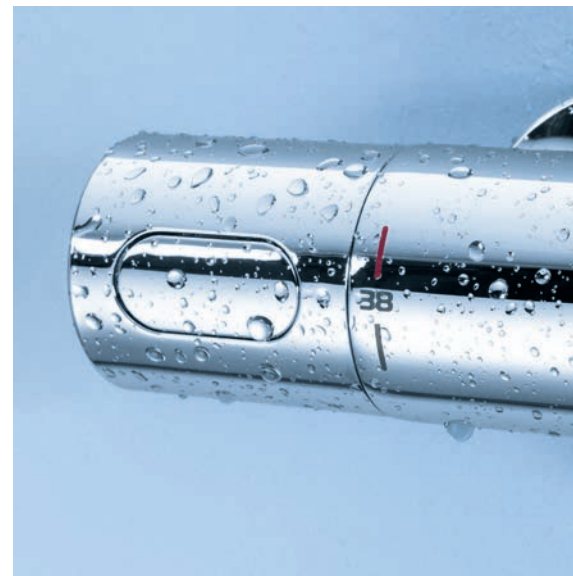

It provides effortless silky-smooth precision-control of water flow and temperature.

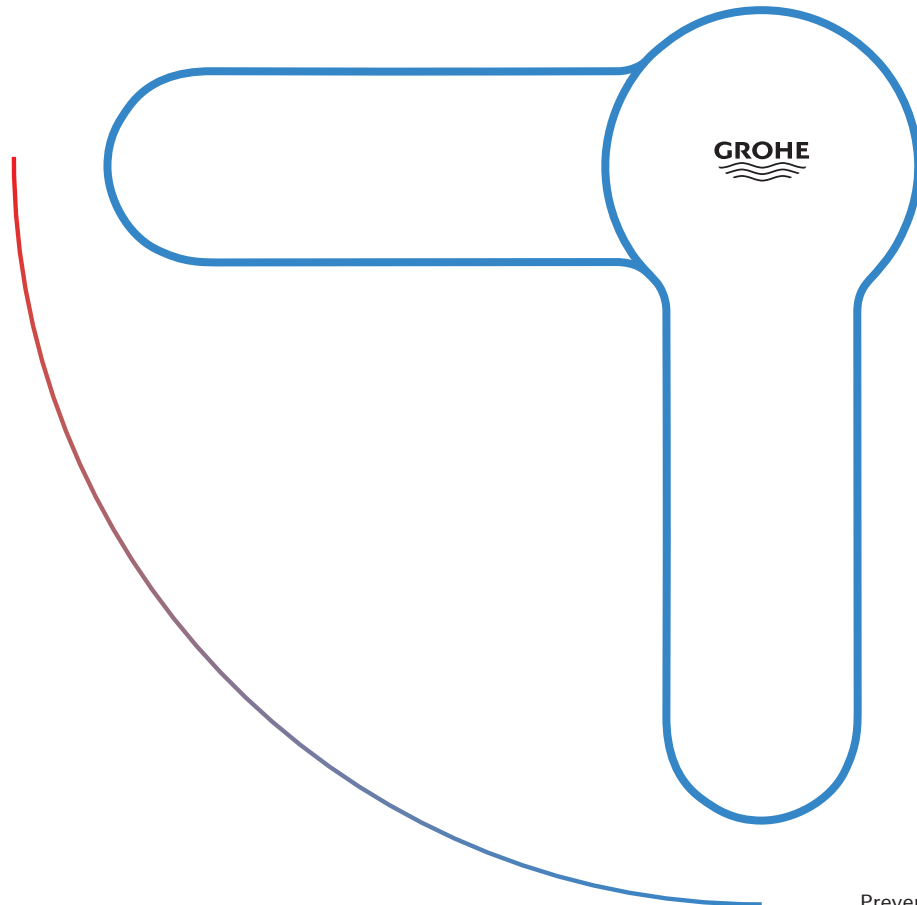

GROHE SILKMOVE ES

Enhanced water experience whilst encouraging responsible management of precious resources.

Prevents unnecessary production of hot water by supplying cold water with the faucet lever in the middle position of the fitting.

By using GROHE TurboStat technology the desired shower temperature is delivered instantly and is kept constant for the duration of the shower.

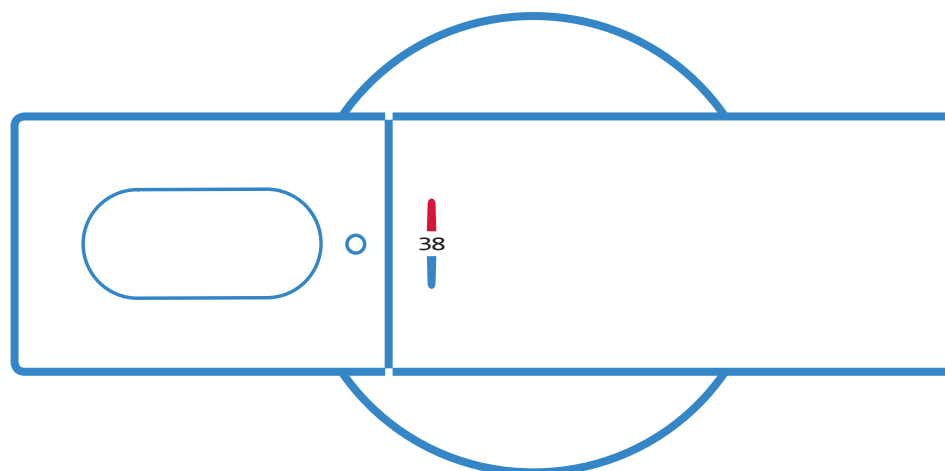

LESS WASTE, **MORE LONGEVITY**

+++ The global economy is increasingly producing mountains of rubbish. +++ This growing waste problem impairs public health, pollutes the environment and threatens to drown poorer countries in toxicity. +++ We can all help reduce the rubbish mountain – with slight changes in our behaviour.



LET'S THROW AWAY LESS AND USE MORE

80 BILLION BOTTLES A YEAR IS UNACCEPTABLE

According to a recent New York University white paper, global waste production has doubled over the past ten years. And a significant part of that waste is plastic water bottles. By 2025, the world will produce rubbish at a rate of 2.5 billion tonnes per year. It's a fact that the more urbanised and industrialised a nation becomes, the more rubbish it produces. On top of that, the "throw-away" society is increasingly escalating – for example, according to the US Federal Environment Agency 60% of all flat TVs that are thrown away and replaced are still working. This growing waste problem impairs public health, pollutes the environment and threatens to drown poorer countries in toxicity.



Global waste production 2007



Global waste production 2017

REUSE, RECYCLE, RETHINK

Once again, by making slight behavioural changes we can all tackle this problem. For example, we can use refillable bottles – in fact, why use bottles for water at all, when we can get it straight from the tap? We can also recycle materials, and choose long-lasting products. We can reuse bags and containers when shopping, or packing lunches and leftovers. We can buy items made from recycled materials. Buying in bulk rather than individual packages will also save money and reduce waste. Remember, packaging accounts for 30% of the weight and 50% of the entire volume of rubbish.



Packaging accounts for 50% of all rubbish by volume

OUR MISSION AT GROHE: **UNBOTTLED WATER**

We offer waste-avoiding products and practice smart activities to reduce rubbish. For example, GROHE Blue is a kitchen system that transforms ordinary tap water into filtered, chilled, still or sparkling water. With a GROHE Blue in the home, families never need to buy water in a plastic bottle again. Based on the European average, for a family of four that means 600 bottles per year. In addition, university studies have shown that our GROHE Blue system saves more than 60% of CO₂.

We also take great care in maximizing the longevity of our products: the average lifetime of GROHE fittings is around 17 years. However, almost all faucet replacements are made because the user wants a more up-to-date looking faucet. That's why our designs are timeless, not trendy, so customers can enjoy them for longer. To ensure a long, reliable lifetime, we also give a five-year warranty on most products and even a 10-year warranty on all concealed parts. In addition, GROHE spare parts are available for at least 15 years. It all adds up to a longer usage lifetime and less waste.



GROHE Blue Home Duo, C-Spout

Reduce your carbon footprint with filtered, sparkling table water.

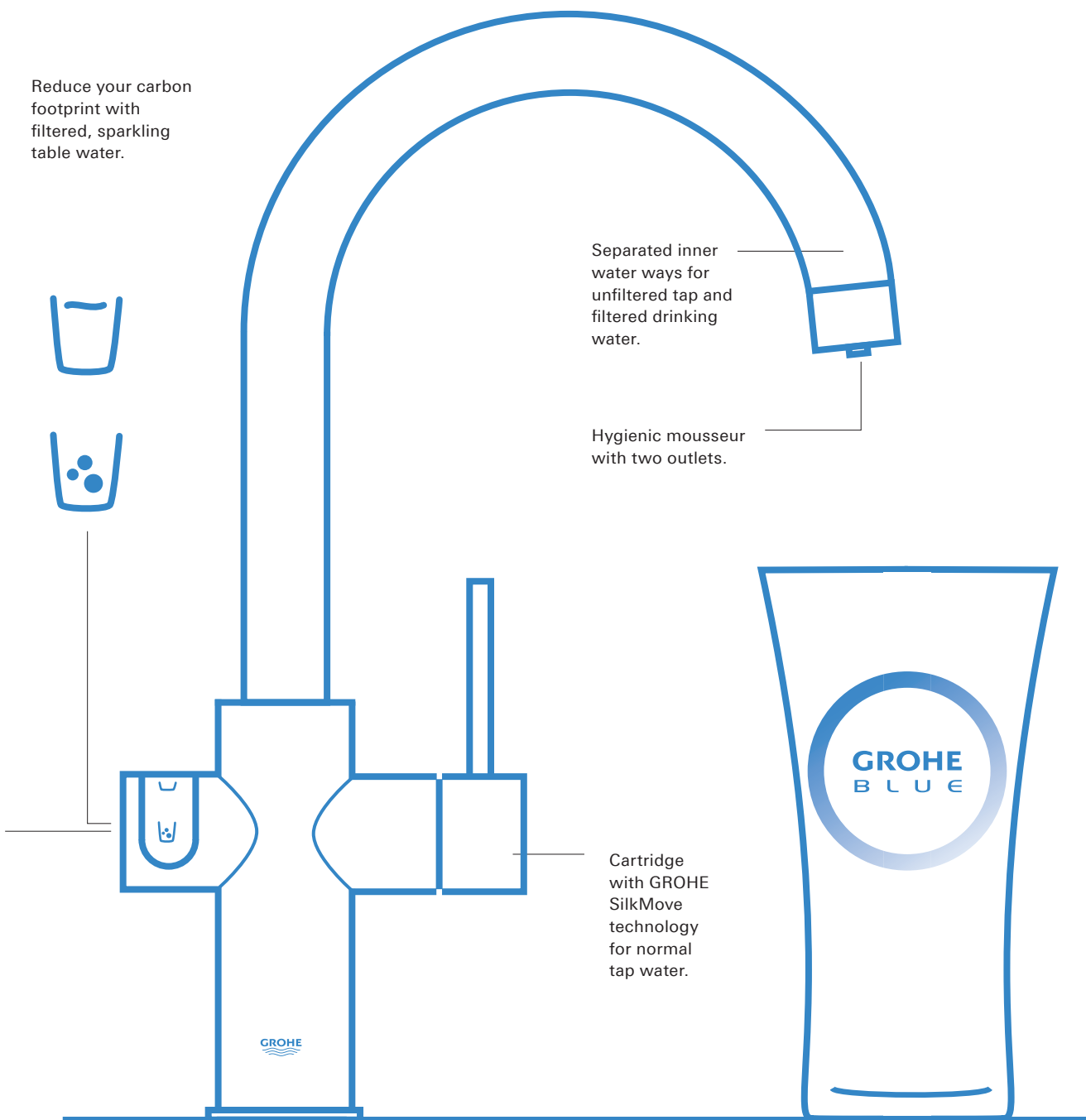

ENHANCED WATER

Superior-quality water directly from the kitchen faucet – saving time, money and the environment

BUILDING **SUSTAINABILITY**

- +++ “Green buildings” make sense; they are more valuable because they reduce the cost of ownership.
- +++ Planners, architects and investors are leading the way towards Green certification.



LET'S SUPPORT YOU **PLANNERS, ARCHITECTS AND INVESTORS**

THE TIME TO MAKE A DIFFERENCE IS NOW

Planners, architects and investors have a historic opportunity: to fully embrace sustainable architecture and shape the future for generations to come. It's an opportunity already being seized by many, because buildings with "green" certifications such as LEED, DGNB and BREEAM not only have less impact on the environment, they are also more valuable since they cost less to operate and maintain. However, one of the easiest ways to build in long-term sustainability is to save energy and resources through correct product selection.



Member of
DGNB

**THE DIFFERENCE THAT
PLANNERS, ARCHITECTS
AND INVESTORS CAN MAKE**

All green building certification methodologies underline the importance of water efficiency within buildings. Planners, architects and investors can insist on clearly specified flow rates of faucets and shower heads.



Using touchless faucets can reduce water consumption by up to 70% and contribute significantly towards green accreditation.

NO NEED, NO FLOW CAN HELP WIN CONTRACTS

With our sustainability credentials, together with our proven resource-saving products such as the GROHE Eurosmart Cosmopolitan E, we are helping planners, architects and investors to gain green building accreditations such as DGNB, LEED and BREEAM.

When it comes to emphasising how resource-conscious a new building design is, nothing beats the notion of “no need – no flow” in sanitation areas. That’s precisely what the GROHE Eurosmart Cosmopolitan E provides. Thanks to infrared sensing, water flows through these faucets only when needed: when a hand is underneath the spout. Depending on the model, the mixer automatically turns off and saves water when the user removes his or her hands, for example when applying soap, or after a pre-set time. The easy-to-clean mixer body makes it ideal for a wide range of buildings, including hotels and restaurants, leisure and sports facilities, hospitals, clinics and schools. And the automated on-off feature will make your new building design proposals that extra bit greener.

With intelligent sensor technology it is even possible to adjust the detection range or flow time according to your needs. Via a remote control it is also possible to monitor the total usage of the faucet and gain insight into the number of litres of water consumed.



Eurosmart Cosmopolitan E,
M-Size, with GROHE EcoJoy
and GROHE StarLight

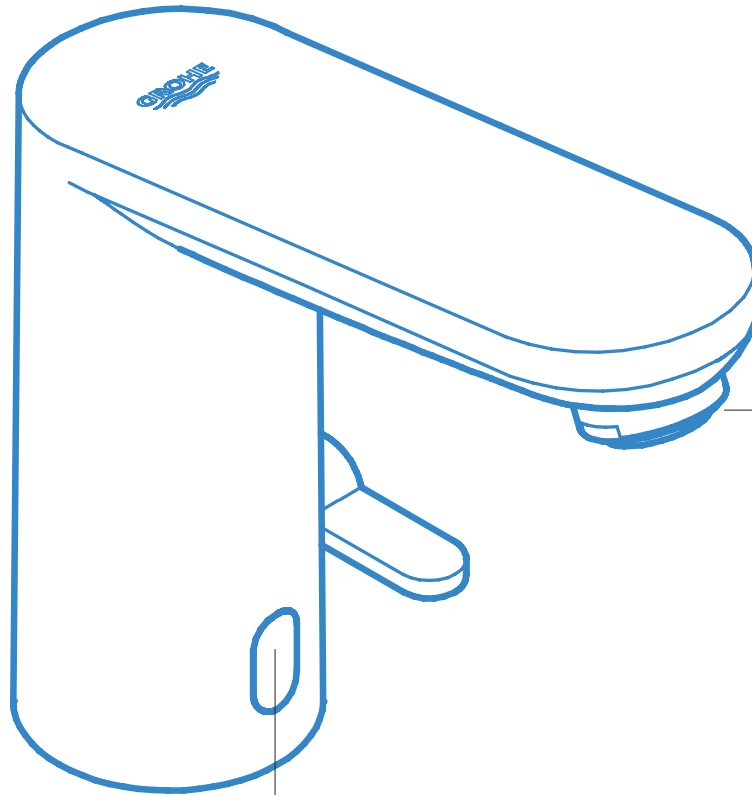

The water flow starts and stops automatically – the instant that the infrared beam is interrupted by the user's hand. This reduces water consumption by up to 70%.



GROHE Eurosmart Cosmopolitan E touchless faucets are controlled using infrared sensors, making them highly economical and supremely hygienic.



GROHE ECOJOY

Save precious resources and enjoy 100% water comfort.

GROHE STARLIGHT

Made-to-last surfaces ranging from precious matt to shiny like a diamond.

SMART PROCESSES INSIDE OUR OPERATIONS

- +++ Not just a responsibility, an absolute passion.
- +++ Saving resources inside and outside our operations.

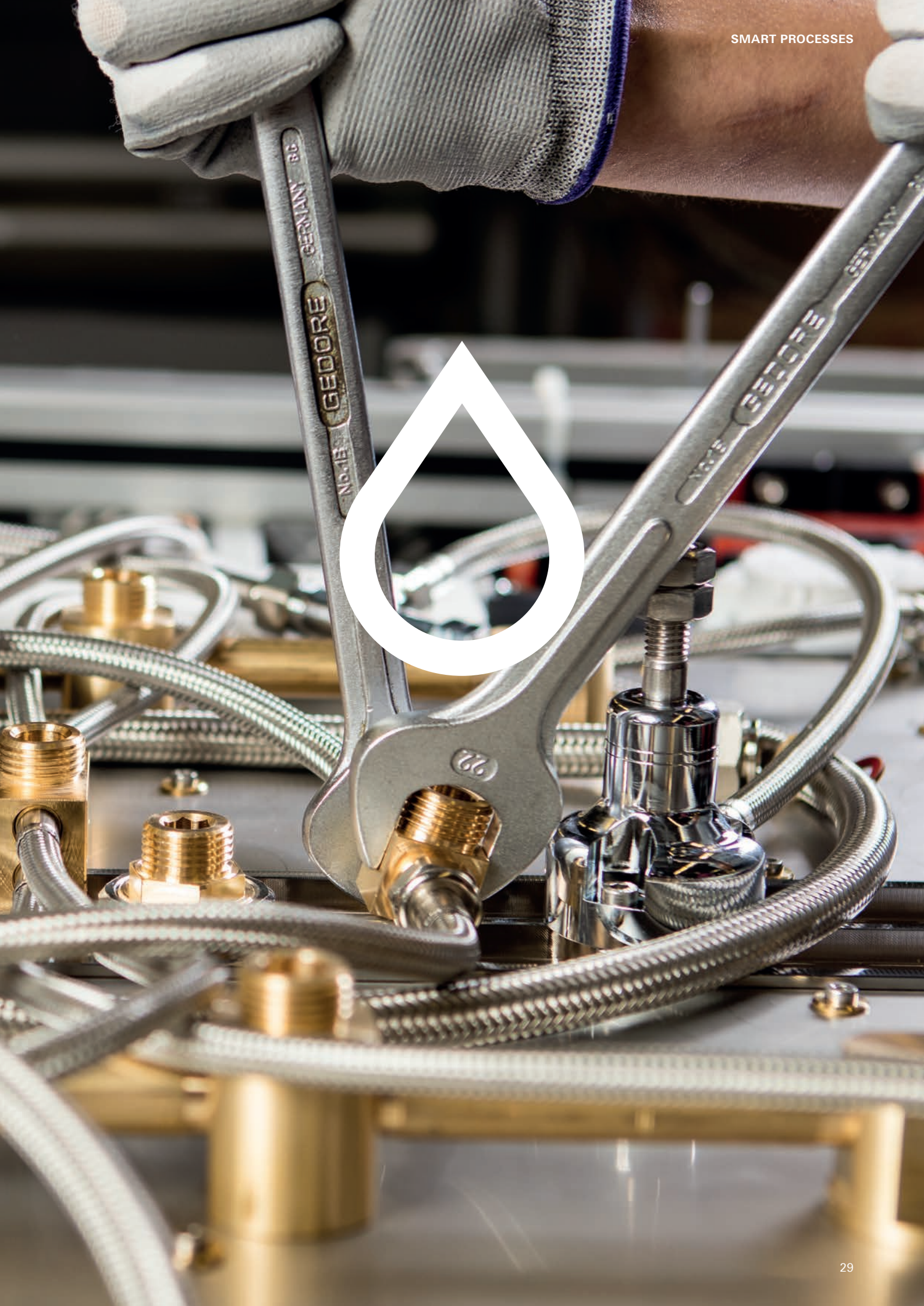

SAVING RESOURCES INSIDE OUR OPERATIONS



EXCEEDING REGULATORY STANDARDS

Sustainability at GROHE is not just a responsibility, it is an absolute passion that we pursue each day. Obviously, we comply with all statutory regulations, but we go further and significantly exceed our regulatory obligations. For example, our new production plant in Thailand is due to be built in 2017 and will be equipped with a range of sustainable features. We aim to achieve the DGNB (German Sustainable Building Council) certification for this plant.

We also train all our employees in best practises for environmental, occupational and health-conscious behaviour. And every GROHE production site has its own “Energy Officer” who ensures that all energy-saving initiatives are applied systematically in accordance with ISO 50001. The result is that our production facilities are continuously minimising their impact on the environment.

20% LESS GAS

We constantly measure the results of our sustainability activities. For example, one of our German factories recently reduced its gas consumption by 20%.



80% WASTE RECOVERY

The waste recovery rate of all GROHE production sites has been steadily increasing for several years and is now more than 80%, including high-impact materials such as GROHE brass.

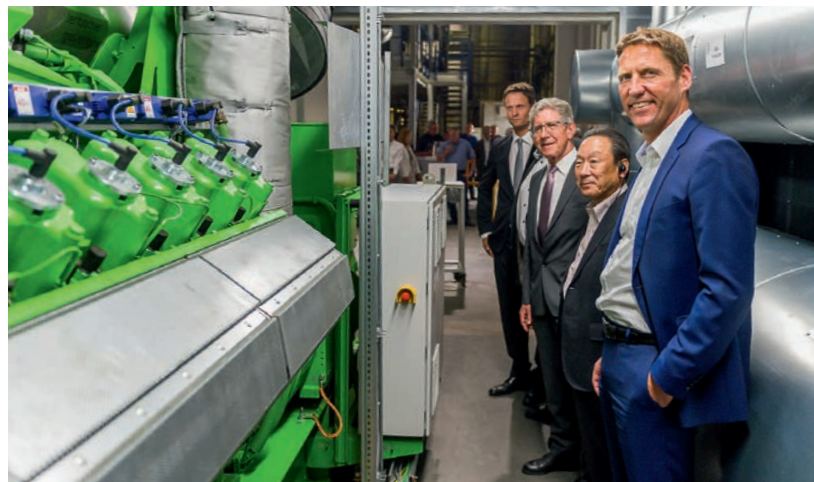



**70%
RENEWABLE PACKAGING**

More than 70% of all the paper we use in packaging is made from renewable material, and 100% of all product descriptions are printed on PEFC-certified paper.



**35%
LESS LEAD**

Thanks to operating our own melting furnaces, we have complete control over the composition of our alloys. That's why we were recently able to reduce the use of lead by 35%, and why we switched our entire brass production to GROHE Light-brass in 2015.



**17,000 TONNES
LESS CO₂**

Two of our production facilities in Germany recently installed combined heat and power plants. These capture the thermal energy produced in electrical power generation and use it to heat water and the surroundings, instead of releasing it into the environment. These plants effectively reduce carbon emissions by more than 17,000 tonnes every year.

Combined heat and power plants at our manufacturing facilities are saving thousands of tonnes of CO₂ emissions.

SAVING RESOURCES OUTSIDE OUR OPERATIONS

CLEARLY DEFINED STANDARDS:

We have developed an agreement with all our suppliers: the GROHE Supplier Code of Conduct. This agreement obliges all global suppliers to comply with ecological and social standards. For several years, GROHE has worked exclusively with external suppliers who agree to the values that are defined in the GROHE Supplier Code of Conduct.

In addition, the GROHE Antitrust Compliance Manual obliges its own employees to demonstrate ethically correct behaviour.

Furthermore, on-site contractors, such as service providers, must accept the GROHE Formal Statement of Obligations for Suppliers.

WORLDWIDE AUDITING

We have also set up independent procedures for worldwide auditing and approval of disposal services. These help prevent our suppliers from illegally disposing of hazardous waste.

ENCOURAGING ETHICAL BEHAVIOUR

Moreover, these agreements oblige our suppliers to respect social standards, human and employee rights, to treat employees with respect and dignity, and to provide acceptable working conditions within the suppliers' facilities. In this way we are achieving sustainable activities backstream from our activities as well as upstream.

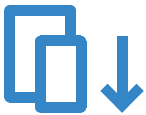

**50%
SMALLER PACKAGING
SAVES RESOURCES**

It's not just lighter products that help save on transport emissions, we also apply our holistic approach to sustainability to save resources and minimise CO₂ emissions in many other areas outside of our operations. For example, the GROHE Rainshower Icon handset not only reduces water consumption by 40% – thanks to the GROHE EcoButton – it is also marketed with resource-efficient packaging.

Compared to the previous product generation, the packaging volume is almost 50% smaller, significantly reducing its carbon footprint in terms of materials usage and transportation.

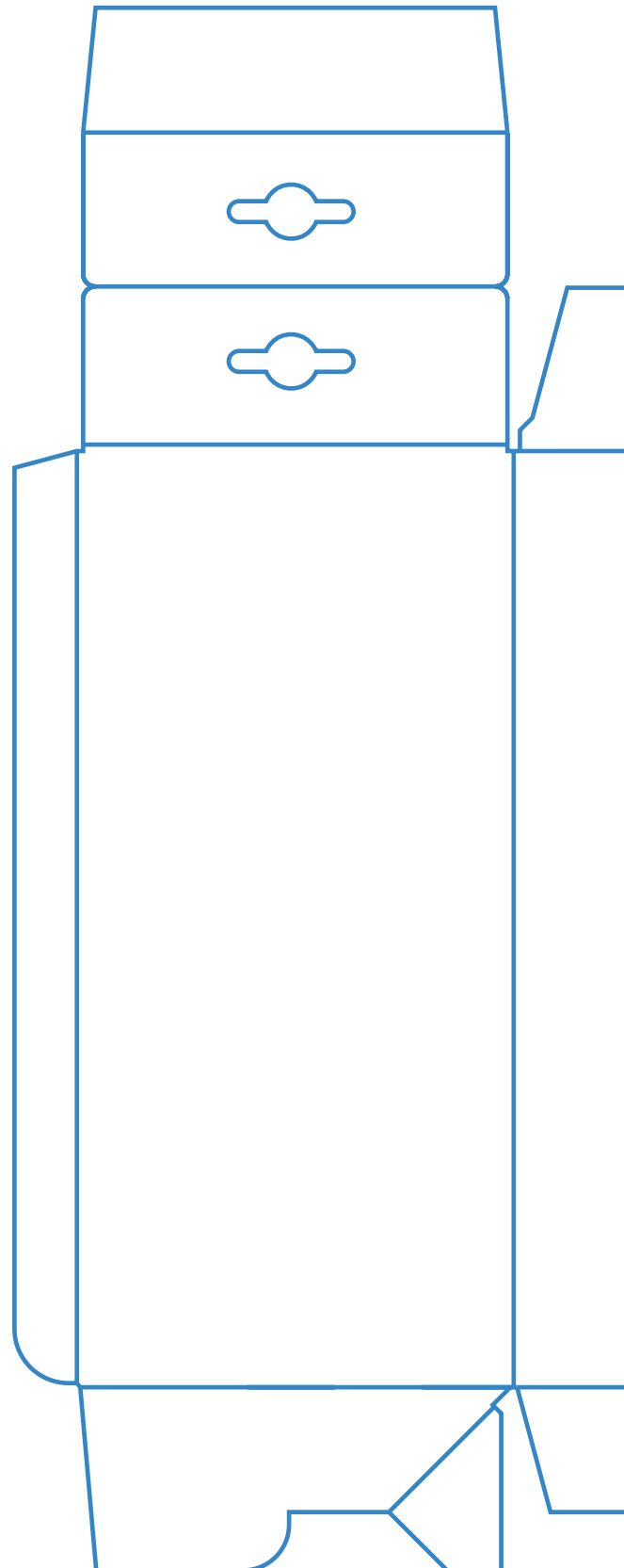

SUSTAINABILITY THROUGH **SOCIAL RESPONSIBILITY**

+++ Our holistic approach to sustainability goes further than saving valuable resources. We also engage in many non-core business activities that promote the people's well-being.



GROHE

ENJOY LIFE

ENJOY WATER

Don Bosco - Grohe Jal Academy

Dedicated to
the training of plumbers by

Mr. Michael Mager,
Vice-President, Grohe, Germany
in the presence of

Fr. Michael Fernandes sdb
Salesian Provincial, Mumbai

7th November 2009

DON BOSCO CENTER FOR

to Life and L

GROHE

GROHE

GRO

IT'S ALL ABOUT PEOPLE

Sustainability not only requires a sense of responsibility for the environment, it also necessitates a sense of responsibility to people. That's why we have an effective compliance system, clear guidelines and a "speak-up" culture at GROHE. In addition, we have our Suppliers Code of Conduct to ensure the ethical treatment of people by our suppliers. We also have our award-winning "Dual Tech" programme that helps disadvantaged people in developing countries.



The GROHE Dual Tech programme offers young people in developing countries a chance to learn the profession of installer.



WIDENING CAREER PATHS

Closer to home we have initiatives to help our own people – especially the young. For example, all our new apprentices are invited to the “Azubi On Tour” (Trainee On Tour) programme, where they receive practical sales training during their apprenticeship. This helps everyone realise their full potential.

AWARD-WINNING TRAINING

Did you know that we train our apprentices in more than 25 different professions at GROHE? And each year around 80 junior talents graduate from our programme. But it is not just about quantities; the quality of our training is of the utmost importance too and continually receives external recognition. Since 2010 seven of our trainees have been honoured with awards for “Best Trainee in Germany”.

GROHE also supports further education with grants to help individuals realise their full potential as well as help ensure an abundance of future professional talent for the company. We also formed our GROHE Master Academy, and most recently we have launched the GROHE-Campus providing a new online Training Portal for all our employees.

EMPLOYEE ENGAGEMENT AT ALL LEVELS

In addition to supporting young employees, GROHE maintains a continuous dialogue with all employees and their special-interest groups. This ensures we can effectively live up to our responsibilities as an employer. Specifically this entails a secure job with fair pay – but also training and further education options. That’s why GROHE has optimised the opportunities in these areas for all our employees, with internal and external seminars, including our special GROHE Potential programme, and the on-boarding programme for new employees. This is the age of lifelong learning, and we want every one of our employees to achieve their full potential.



GROHE'S SOCIAL ENGAGEMENT

At the heart of sustainability is a powerful sense of responsibility – a responsibility that naturally extends from environment and people to society in general. And in particular, disadvantaged societies. That's why GROHE and our employees actively support societal improvement projects worldwide.



GROHE Dual Tech opening in Manila-Tondo, Philippines: The programmes of GROHE Dual Tech in the Philippines are targeted at socially disadvantaged people aged 17 to 25 who are unable to obtain vocational training otherwise.

One of our societal improvement projects provides disadvantaged families with food packages during the Islamic holy month of Ramadan



FREE TRAINING

One of the most powerful examples of our social engagement is our Dual Tech Programme.

It started in 2009 with the opening of the GROHE Jal Academy (English: Water Academy) in Mumbai, India, at the Don Bosco Centre for Learning. The academy gives young men from disadvantaged backgrounds training as installers. This provides them with the skills to earn a livelihood as well as helping to ensure the continuity of their community's water supply. Since it began in 2009, the academy has trained around 800 apprentices.

The project won first prize in the "Innovation Competition for Professional Training in Developing Countries", awarded by the German Federal Ministry for Economic Cooperation and Development.



MORE THAN FINANCIAL SUPPORT – PERSONAL INVOLVEMENT TOO

The original idea for a social project in India was developed by GROHE management trainees during an advanced training course. It was clear from the start that GROHE did not want to merely provide financial support to the academy, our employees also wanted to help personally. The volunteers even used part of their own annual holiday time to travel to India and pass on their expertise. Most importantly, this training initiative is aimed at providing people with marketable skills. In this way we truly help society and do not simply fill vacant positions in our own ranks. GROHE not only continues to run this award-winning project in Mumbai, we have also rolled it out in New Delhi in India and Manila-Tondo in the Philippines.

LOCAL EXAMPLES OF GROHE'S SOCIAL RESPONSIBILITY

The GROHE team in Jodhpur, India supported the "Clean India Movement" urban cleaning operation and volunteered to clean public toilets. While in the Kingdom of Saudi Arabia, we launched the "Turn Water Into Food" (TWIF) project in 2015. This initiative, in cooperation with mosque foundations, builds on food distribution for disadvantaged people throughout the holy month of Ramadan. This unique idea is based on transforming the water saved by furnishing mosques with self-closing faucets into food. For every 10 litres of water saved, GROHE donates one food pack to a family. To date, more than 2,360 families have benefited from this programme. Following the success of the initiative in Saudi Arabia, Egypt and Turkey and in partnership with the Food Bank Network the TWIF will soon be introduced in Bahrain, UAE, Ghana, Lebanon and Jordan.

OUR ENTIRE GROUP IS PASSIONATE

Our parent company LIXIL and all of its members are also passionate about sustainability. That's why LIXIL has set itself a highly ambitious and thought-leading goal. As part of the LIXIL Group Corporation, GROHE participates in this vision and fully supports the efforts to achieve this aim:

PART OF **LIXIL**

“By 2030, the positive environmental contribution from our products and services will surpass the environmental footprint from our entire business process, thus achieving a NET ZERO environmental footprint.”



MAKING A DIFFERENCE TO MILLIONS

Like GROHE, LIXIL is also socially engaged in many projects and activities. One of them addresses the needs of the estimated 2.4 billion people who live without access to proper sanitation. Today, an estimated 800 children under five years of age die every day from diarrheal disease caused by lack of hygienic water and sanitary living conditions, and 950 million people defecate in the open.

To address this critical problem, LIXIL has created the SATO ("Safe Toilet") products, which are designed to improve the user experience and keep flying insects out. They are refined yet affordably priced and simple to install. They utilise an airtight counterweighted trapdoor to prevent odours and the transmission of disease. First developed by LIXIL's American Standard Brands with funding from the Bill & Melinda Gates Foundation, over 1 million units are currently in use in over 14 countries, starting with Bangladesh and now including the Philippines, India, Uganda, Kenya and Haiti, and have helped LIXIL enable access to safe and hygienic

sanitation for approximately 5 million people.

Kinya Seto, LIXIL President and CEO, said, "As the global leader in sanitary ware, LIXIL is uniquely positioned to contribute to tackling global sanitation issues through innovative products and a sustainable business-focussed approach. LIXIL has set a goal to improve sanitation for 100 million people by 2020, and SaTo products will play a leading role in reaching this target. We now look forward to increasing SaTo's presence in regions like Sub-Saharan Africa and South Asia, where these products can make a meaningful difference." With these stated intentions, LIXIL has not only set itself an important mission but will also help to achieve the 6th Sustainable Development Goal of the UN: to ensure clean water and sanitation for all.

SUSTAINABILITY IS A PART OF OUR STRATEGY- NOT A COMPROMISE

GROHE has always been sustainable without even knowing that this behaviour is called "being sustainable". For us sustainability is a part of our DNA.

But GROHE finds itself in a unique situation. Unlike with many companies that produce increasingly sustainable products in a sustainable manner, our customers do not lose any comfort or performance. Smart features, such as GROHE EcoJoy, which limits the flow rate but simultaneously creates a full-flow feeling, ensure that our customers can experience the pure joy of water every day, and still save resources in the process.

That's why you could say that GROHE is really in the business of "sustainability without compromise". We make no compromise in our activities and neither do our market partners. And most importantly, each time our customers use our products they save a little water and a little energy, and they can enjoy being responsible citizens.



**ENSURING WATER ENJOYMENT
FOR GENERATIONS TO COME**

Follow us



Just scan the QR code to view the latest brochure as download or PDF on your tablet or smartphone.

Grohe AG
Feldmühleplatz 15
40545 Düsseldorf
Germany

© 03/2017 Copyright by GROHE

PART OF **LIXIL**